

SHURE®

LEGENDARY
PERFORMANCE™

Wired Microphones
BETA181

BETA 181

Side-Address Condenser Microphone

Microphone électrostatique à capture latérale

Von der Seite zu besprechendes Kondensatormikrofon

Microfono a condensatore con ripresa laterale

Micrófono de condensador de captación lateral

Конденсаторный микрофон с боковым приемом

サイドアドレスコンデンサー型マイクロホン

사이드-어드레스 콘덴서 마이크

侧向拾音电容式话筒



General Description

The Shure Beta 181 is an ultra-compact, side-address, condenser microphone, designed for discreet placement in live and studio environments. Featuring interchangeable cardioid, supercardioid, omnidirectional and bidirectional capsules for superior versatility, the small diaphragm of the Beta 181 provides superior audio with consistent, “textbook” polar responses in a form factor small enough to get close to the source in the tightest conditions.

Variations

- 🔊 **Beta 181/C** Cardioid Microphone
- 🔊 **Beta 181/S** Supercardioid Microphone
- 🔊 **Beta 181/O** Omnidirectional Microphone
- 🔊 **Beta 181/BI** Bidirectional Microphone

Features

- Premier live performance microphone with Shure quality, ruggedness, and reliability
- Compact preamp attaches to four interchangeable capsules
- Wide dynamic range for use in high SPL environments
- Side-address form allows for discreet positioning in tight performance and recording settings
- Innovative locking ring provides a secure connection between capsule and preamp
- Hardened steel mesh grille resists denting, wear, and abuse
- Compact design, under 12 cm (5 in.), reduces stage clutter
- Furnished with stand adapter and carrying case

Performance Characteristics

- Exceptional low-frequency reproduction
- Extremely high SPL handling
- High output level
- No crossover distortion
- Transformer output

Applications and Placement

Positioning the Microphone

The front of the microphone is marked by the Shure logo on the preamp and the polar pattern icon on the capsule. Position this side toward the sound source.

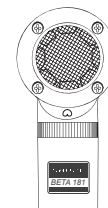

General Rules for Use

- Aim the microphone toward the desired sound source; angle unwanted sounds toward its *null* point.
- Use the fewest amount of microphones as practical to increase the *Potential Acoustic Gain* and prevent feedback.
- Follow the *3 to 1 Rule* by spacing each microphone by at least three times the distance to its source to reduce *Phase Cancellation*.
- Place microphones as far as possible from reflective surfaces to reduce *Comb Filtering*.
- When using directional microphones, work closely to the microphone for extra bass response to take advantage of *Proximity Effect*.
- Avoid excessive handling to minimize pickup of mechanical noise and vibration.
- Do not cover any part of the microphone grille, as this will adversely affect microphone performance.
- Add a windscreen when using the microphone outdoors.

The following table lists the most common applications and placement techniques. Keep in mind that microphone technique is largely a matter of personal taste; there is no one “correct” microphone position.

Cardioid	Supercardioid	Omnidirectional	Bidirectional
<ul style="list-style-type: none"> • Drum overheads • Piano • Acoustic instruments • Pair with a Beta 181/BI for M/S stereo technique 	<ul style="list-style-type: none"> • Close-miking in performance settings • Snare drum • Acoustic instruments 	<ul style="list-style-type: none"> • Room and ambient pickup • Mono drum overhead • String ensembles 	<ul style="list-style-type: none"> • Use a pair of Beta 181/BI for Blumlein stereo technique • Mono drum overhead • Dual sound sources, such as between tom-toms or acoustic instruments

Note: As with all bidirectional microphones, sounds picked up from the back will be out of polarity with the source. Those from the front are in polarity with the source.

Changing Capsules

Follow these steps to change Beta 181 capsules:

1. Turn off phantom power and disconnect from equipment.
2. Unscrew the capsule’s knurled ring to detach the preamp.
3. Slide the alignment key on the bottom of the capsule into the groove on the preamp to ensure that the Shure logo displays the front of the microphone.
4. Tighten the knurled ring to securely reconnect the microphone.

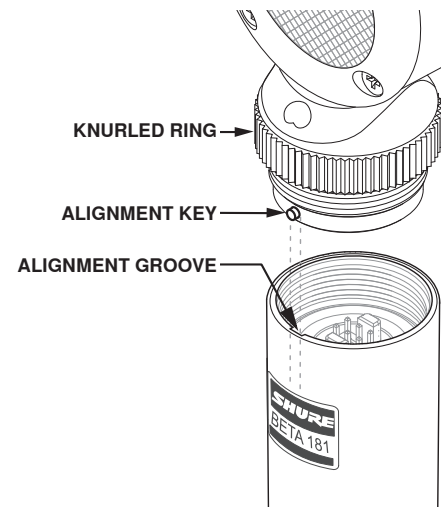
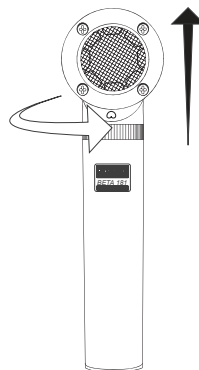

NOTE: Before each use, make sure the capsule is tightly secured on the microphone, as vibration and accidental hits with drumsticks may loosen it, resulting in signal loss.

Load Impedance

Maximum SPL capability, output clipping level, and dynamic range vary with the input load impedance of the preamplifier to which you connect the microphone. Shure recommends a minimum input load impedance of 1000 Ω . Most modern microphone preamplifiers meet this requirement. Higher impedance results in better performance for these specifications.

Power Requirements

This microphone requires phantom power and performs best with a 48 Vdc supply (IEC-61938). However, it will operate with slightly decreased headroom and sensitivity with supplies as low as 11 Vdc.

Most modern mixers provide phantom power. You must use a **balanced** microphone cable: XLR-to-XLR or XLR-to-TRS.

Accessories and Parts

Furnished Accessories

Mic Clip	A57F
Zippered Carrying Case	A181C
Windscreen	A181WS

Optional Accessories

Cardioid Capsule	RPM181/C
Supercardioid Capsule	RPM181/S
Bidirectional Capsule	RPM181/BI
Omnidirectional Capsule	RPM181/O
Beta 181 Preamp	RPM181/PRE
Universal Microphone Mount	A75M
Shock Stopper™ Isolation Mount	A53M
7.6 m (25 ft.) Cable	C25E

CERTIFICATION

Eligible to bear CE Marking. Conforms to European EMC Directive 2004/108/EC. Meets Harmonized Standards EN55103-1:1996 and EN55103-2:1996, for residential (E1) and light industrial (E2) environments.

The Declaration of Conformity can be obtained from:

Authorized European representative:

Shure Europe GmbH

Headquarters Europe, Middle East & Africa

Department: EMEA Approval

Wannenacker Str. 28

D-74078 Heilbronn, Germany

Phone: +49 7131 72 14 0

Fax: +49 7131 72 14 14

Email: EMEAsupport@shure.de

Note: Information in this guide is subject to change without notice. For the additional information about this product, please visit www.shure.com.

Avoiding Pickup of Unwanted Sound Sources

Directional microphones are most sensitive to sounds arriving on axis and reject at angles depending upon the polar pattern. The following chart shows the rejection angles of each microphone. In live performance or recording settings, align monitors, P.A. loudspeakers, and unwanted sound sources at these angles.

To minimize feedback and ensure optimum rejection of unwanted sound, always test microphone placement before a performance.

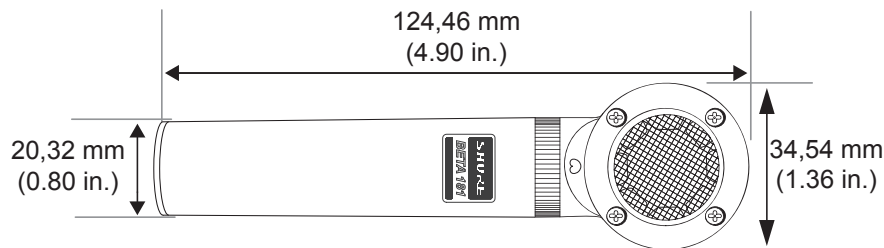
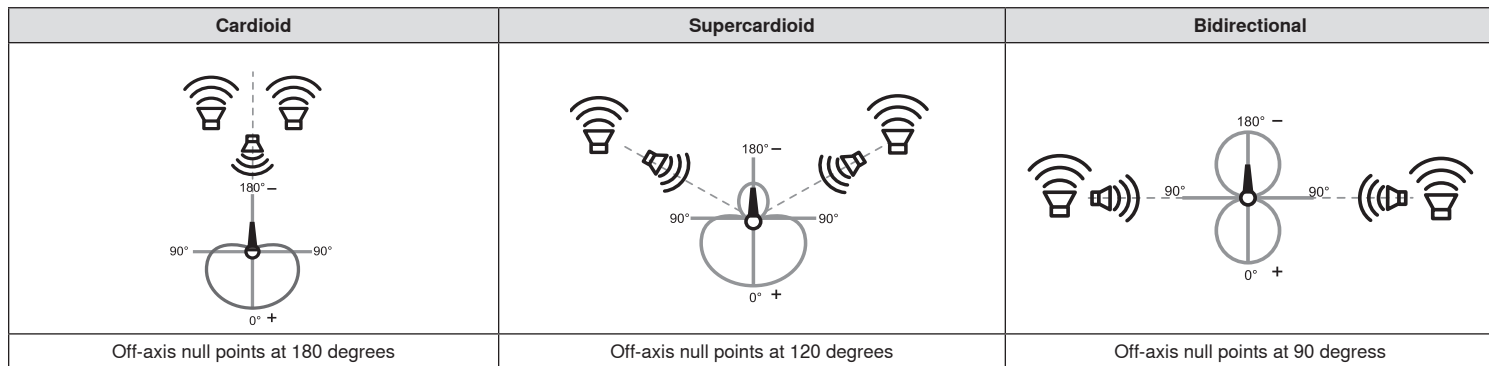

SPECIFICATIONS

Cartridge Type	Electret Condenser		
Polar Pattern	181/C:	Cardioid	
	181/S:	Supercardioid	
	181/O:	Omnidirectionnel	
	181/BI:	Bidirectional	
Frequency Response	20 to 20,000 Hz		
Output Impedance	110 Ω		
Sensitivity open circuit voltage, @ 1 kHz, typical	Cardioid:	-46.5 dBV/Pa ^[1] (4.7 mV)	
	Supercardioid:	-49.5 dBV/Pa ^[1] (3.4 mV)	
	Omnidirectional:	-52.0 dBV/Pa ^[1] (2.5 mV)	
	Bidirectional:	-51.0 dBV/Pa ^[1] (2.8 mV)	
Maximum SPL 1 kHz at 1% THD ^[2]	2500 Ω load:	Cardioid:	151.5 dB SPL
		Supercardioid:	154.5 dB SPL
		Omnidirectional:	157.0 dB SPL
		Bidirectional:	156.0 dB SPL
	1000 Ω load:	Cardioid:	149.0 dB SPL
		Supercardioid:	152.0 dB SPL
		Omnidirectional:	154.0 dB SPL
		Bidirectional:	153.5 dB SPL
Signal-to-Noise Ratio ^[3]	Cardioid:	73.5 dB	
	Supercardioid:	71.5 dB	
	Omnidirectional:	70.5 dB	
	Bidirectional:	71.0 dB	
Dynamic Range	2500 Ω load:	Cardioid:	131.0 dB
		Supercardioid:	132.0 dB
		Omnidirectional:	133.5 dB
		Bidirectional:	133.0 dB
	1000 Ω load:	Cardioid:	128.5 dB
		Supercardioid:	129.5 dB
		Omnidirectional:	130.5 dB
		Bidirectional:	130.5 dB
Clipping Level @ 1 kHz, 1% THD	2500 Ω load:	10.5 dBV	
	1000 Ω load:	7.5 dBV	
Self Noise equivalent SPL, A-weighted, typical	Cardioid:	20.5 dB SPL-A	
	Supercardioid:	22.5 dB SPL-A	
	Omnidirectional:	23.5 dB SPL-A	
	Bidirectional:	23.0 dB SPL-A	
Common Mode Rejection 20 to 20,000 kHz	≥55 dB		
Polarity	Positive pressure on diaphragm produces positive voltage on pin 2 with respect to pin 3		
Power Requirements	11–52 V DC ^[4] phantom power (IEC-61938) 2.4 mA, maximum		
Net Weight	145 g (5.1 oz.)		

^[1] 1 Pa=94 dB SPL

^[2]THD of microphone preamplifier when applied input signal level is equivalent to cartridge output at specified SPL

^[3]S/N ratio is the difference between 94 dB SPL and equivalent SPL of self noise, A-weighted

^[4]All specifications measured with a 48 Vdc phantom power supply. The microphone operates at lower voltages, but with slightly decreased headroom and sensitivity.

Caractéristiques

Type de capsule	Condensateur à électret		
Courbe de directivité	181/C:	Cardioïde	
	181/S:	Supercardioid	
	181/O:	Omnidirectionnel	
	181/BI:	Bidirectionnel	
Réponse en fréquence	20 à 20,000 Hz		
Impédance de sortie	110 Ω		
Sensibilité tension en circuit ouvert, à 1 kHz, typique	Cardioïde:	-46.5 dBV/Pa ^[1] (4.7 mV)	
	Supercardioid:	-49.5 dBV/Pa ^[1] (3.4 mV)	
	Omnidirectionnel:	-52.0 dBV/Pa ^[1] (2.5 mV)	
	Bidirectionnel:	-51.0 dBV/Pa ^[1] (2.8 mV)	
SPL maximum 1 kHz avec DHT de 1 % ^[2]	Charge de 2500 Ω:	Cardioïde:	151.5 dB SPL
		Supercardioid:	154.5 dB SPL
		Omnidirectionnel:	157.0 dB SPL
		Bidirectionnel:	156.0 dB SPL
	Charge de 1000 Ω:	Cardioïde:	149.0 dB SPL
		Supercardioid:	152.0 dB SPL
		Omnidirectionnel:	154.0 dB SPL
		Bidirectionnel:	153.5 dB SPL
Rapport signal/bruit ^[3]	Cardioïde:	73.5 dB	
	Supercardioid:	71.5 dB	
	Omnidirectionnel:	70.5 dB	
	Bidirectionnel:	71.0 dB	
Plage dynamique	Charge de 2500 Ω:	Cardioïde:	131.0 dB
		Supercardioid:	132.0 dB
		Omnidirectionnel:	133.5 dB
		Bidirectionnel:	133.0 dB
	Charge de 1000 Ω:	Cardioïde:	128.5 dB
		Supercardioid:	129.5 dB
		Omnidirectionnel:	130.5 dB
		Bidirectionnel:	130.5 dB
Niveau d'écrêtage à 1 kHz, DHT de 1 %	Charge de 2500 Ω:	10.5 dBV	
	Charge de 1000 Ω:	7.5 dBV	
Bruit propre équivalent SPL, pondéré en A, typique	Cardioïde:	20.5 dB SPL-A	
	Supercardioid:	22.5 dB SPL-A	
	Omnidirectionnel:	23.5 dB SPL-A	
	Bidirectionnel:	23.0 dB SPL-A	
Rejet en mode commun 20 à 20,000 kHz	≥55 dB		
Polarité	Une pression acoustique positive sur le diaphragme produit une tension positive sur la broche 2 par rapport à la broche 3.		
Alimentation	11–52 V c.c. ^[4] alimentation fantôme (IEC-61938) 2.4 mA, maximum		
Poids Net	145 g (5.1 oz)		

^[1] 1 Pa=94 dB SPL

^[2]La DHT du préamplificateur du microphone appliquée au niveau du signal d'entrée est équivalente au niveau de sortie de la capsule pour la valeur SPL spécifiée.

^[3]Le rapport signal/bruit est la différence entre le niveau SPL de 94 dB et le niveau SPL équivalent du bruit propre pondéré A.

^[4]Toutes les caractéristiques techniques ont été mesurées avec une source d'alimentation fantôme de 48 V c.c. Le microphone fonctionne à des tensions plus basses mais au prix d'une plage dynamique et d'une sensibilité légèrement réduites.

Beta 181/C

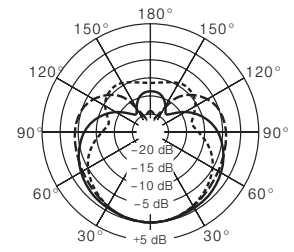
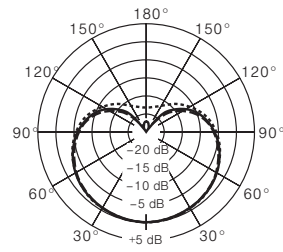
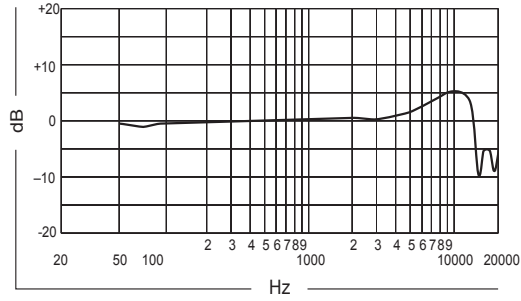

Beta 181/S

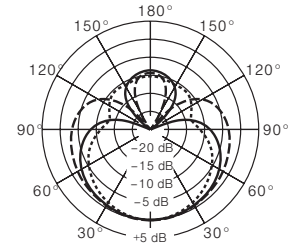
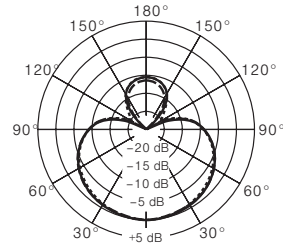
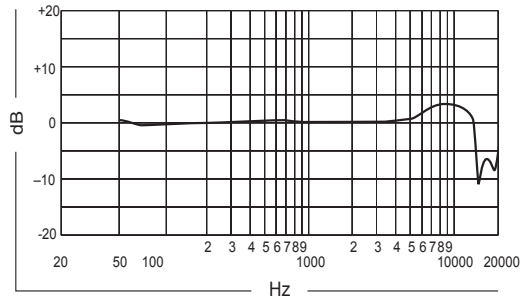

Beta 181/O

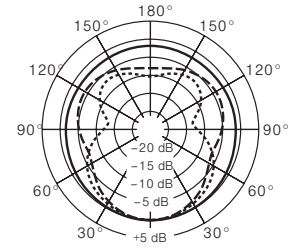
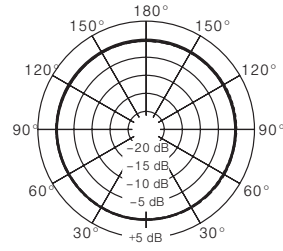
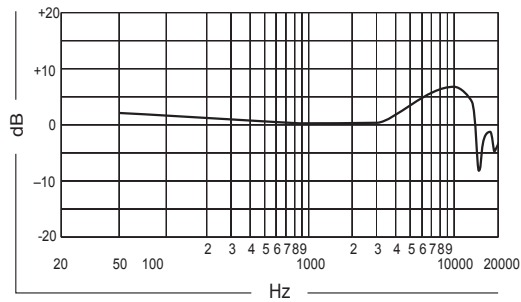

Beta 181/BI

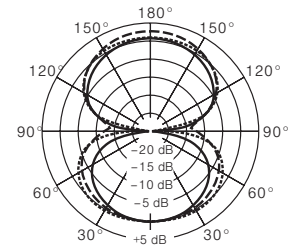
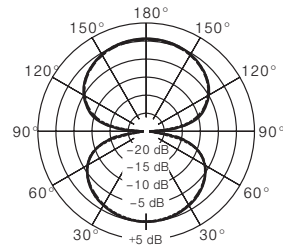
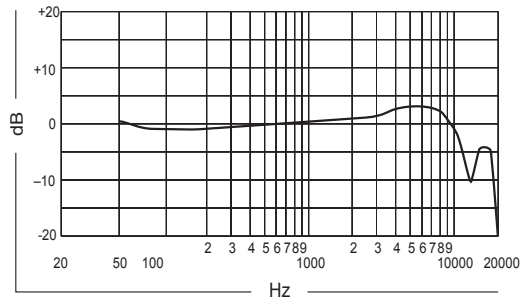



**United States, Canada, Latin
America, Caribbean:**

Shure Incorporated
5800 West Touhy Avenue
Niles, IL 60714-4608 USA

Phone: 847-600-2000
Fax: 847-600-1212 (USA)
Fax: 847-600-6446
Email: info@shure.com

www.shure.com

©2012 Shure Incorporated

Europe, Middle East, Africa:

Shure Europe GmbH
Jakob-Dieffenbacher-Str. 12,
75031 Eppingen, Germany

Phone: 49-7262-92490
Fax: 49-7262-9249114
Email: info@shure.de

Asia, Pacific:

Shure Asia Limited
22/F, 625 King's Road
North Point, Island East
Hong Kong

Phone: 852-2893-4290
Fax: 852-2893-4055
Email: info@shure.com.hk