



RDL®
Radio Design Labs

SPECIALISTS IN PRACTICAL PRECISION ENGINEERING™

max TX™ SERIES TWISTED PAIR Model TX-TPS1A Format-A Single-Pair Sender

- Single -10 dBV Unbalanced or +4 dBu Balanced Input
- Phono Jack and Detachable Terminal Block Inputs
- Switch Selects which RJ45 Pair (A, B or C) is Fed
- Signal and Power Pair Pass-Through from LOOP IN Jack
- Powered Locally or Remotely through RJ45 Jack
- Fused Local Power Feeds all Modules Connected to RJ45s
- Local Power Input on Terminal Block or dc Power Jack
- Blue LED Indicates Module is Powered
- Daisy-Chain with Single-Pair or Two-Pair Format-A Senders
- Studio-Quality Precision Active Balanced Circuitry
-



The TX-TPS1A is a single-pair audio sending module compatible with RDL Format-A twisted pair products. It is built in the versatile Max-TX series enclosure. The durable adhesives provided with the TX-TPS1A permit permanent or removable mounting. The TX-TPS1A may be rack or surface mounted with optional TX™ series accessories.

APPLICATION: The TX-TPS1A is a single-pair audio sending module compatible with RDL Format-A twisted pair products. One line-level source may be connected to the module using either the -10 dBV unbalanced RCA phono jack or the +4 dBu balanced detachable terminal block. A studio-quality buffer amplifier feeds the RJ45 OUTPUT at the correct operating level.

The TX-TPS1A is a single-pair sender, feeding the input signal to the cable pair set on the front-panel switch during installation. This module drives only one cable pair, therefore a LOOP IN RJ45 jack is provided to accept signals and power from other mic-level or line-level Format-A senders. Two other single-pair senders may be chained to the LOOP IN jack, or a single two-pair sender may be connected. If three single-pair senders are connected together, each sender must feed a different pair: A, B or C. The TX-TPS1A must be set to feed pair A if it is connected together with an RDL two-pair sender that feeds stereo audio on pairs B and C.

The TX-TPS1A may be powered directly from a 24 Vdc power supply using either the power jack or the detachable terminal block. Local power connected to the module is also fed to all modules connected to the LOOP IN and OUTPUT RJ45 jacks. The TX-TPS1A may be remotely powered through the twisted pair cable from any other module, signal distributor or RDL power inserter connected to the same twisted pair cable. Module power is indicated by a front-panel LED.

RDL FORMAT-A features superior audio performance that rivals or exceeds shielded wiring. Design simplicity, ease of installation, unsurpassed flexibility, automatic fused power, exceptional hum rejection, low noise, and low distortion provide designers and installers the optimum choice in economical twisted pair products.



max TX™ SERIES TWISTED PAIR
Model TX-TPS1A
Format-A Single-Pair Sender

Installation/Operation



EN55103-1 E1-E5; EN55103-2 E1-E4
Typical Performance reflects product at publication time exclusive of EMC data, if any, supplied with product. Specifications are subject to change without notice.

STEP 1: Set the **PAIR** selector so the module is driving the desired pair A, B or C of the Format-A cable. If the module is connected together with one or two other single-pair senders, each sender must be set to a different pair. If connected together with a two-pair sender, the switch must be set to pair A.

STEP 2: Connect an audio source to one of the inputs (+4 dBu balanced terminal block, or -10 dBV input jack).

STEP 3: Connect 24 Vdc to the **POWER** input (terminals or jack) if this module is not being powered through the twisted pair cable from another module, or if this module is located an excessive distance from the next powered module on the cable. Note: The front-panel power LED will be illuminated if this module is powered. If this module is powering other modules through the cable and if there is a wiring short, the short must be cleared then power must be turned off to this module for 10 seconds to reset the internal protection circuit.

STEP 4: Connect the twisted pair cable(s) and mount the module.

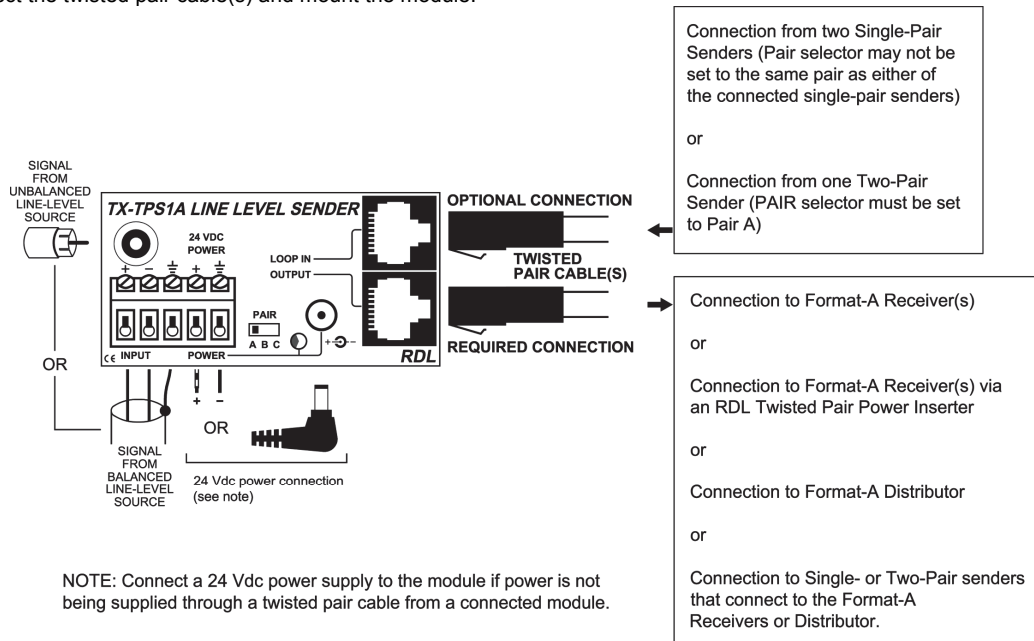

RJ45 Standard wiring

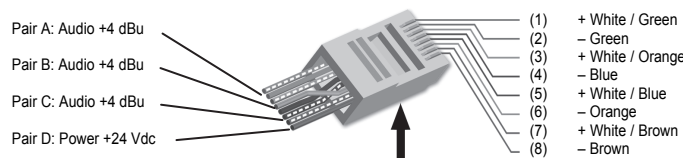

Tab on bottom of connector

RJ45 conductor colors shown are for 568A standard. The 568B standard may be used if the connectors at both ends of the cable are wired identically.

TYPICAL PERFORMANCE

Inputs (2): 20 kΩ balanced; 10 kΩ unbalanced
 Input Connection: Terminal Block (Bal.); Phono Jack (Unbal.)
 Input Level: +4 dBu Bal.; -10 dBV Unbal.; +22 dBu Max
 Format-A Signal Pair Used: Switch-selectable A, B, or C
 Format-A Input: RJ45 LOOP IN
 Output: RDL TP Format-A
 Output Connection: RJ45
 Frequency Response: 10 Hz to 50 kHz (+/- 0.1 dB)
 THD+N: < 0.005%

Noise below +4 dBu: < 90 dB
 Headroom above +4 dBu: > 18 dB
 CMRR: > 60 dB (50 Hz to 150 Hz)
 Indicator: Power In
 Power Connections (3): Power Jack; Detachable Terminal Block; RJ45
 Power Requirement: 24 Vdc @ 35 mA plus connected loads
 Maximum Load Current: 165 mA
 Dimensions: 3.0" (7.6 cm) W; 1.6" (4.08 cm) H; 2.09" (5.3 cm) D

Radio Design Labs Technical Support Centers

U.S.A. (800) 933-1780, (928) 778-3554; Fax: (928) 778-3506

Europe [NH Amsterdam] (+31) 20-6238 983; Fax: (+31) 20-6225-287