



ADX3

Plug-On Transmitter

Online user guide for the Axient Digital ADX3 plug-on transmitter with ShowLink for remote transmitter control and interference management.
Version: 2.0 (2024-B)

Table of Contents

		Utilities Menu	18
ADX3 Plug-On Transmitter	4	Home Screen Display	19
ADX3 Plug-On Transmitter	4	Locking the Interface	19
Important Safety Information	4	IR Sync	20
IMPORTANT SAFETY INSTRUCTIONS	8	Setting the Frequency Manually	20
WARNING	9	RF Mute	21
Features	9	Safe Start	21
Performance	10	Input Overload	22
Design	10	Tone Generator	22
Power	10	Matching Audio Levels with Offset	23
ADX3 Transmitter Overview	10	Updating Firmware	23
Setup	12	Firmware Versioning	23
Transmitter Controls	13	Updating the Transmitter	24
Shure Rechargeable Battery	14	Troubleshooting	24
Shure SB900B-Series Runtime	14	Power	24
Important Tips for Care and Storage of Shure Rechargeable Batteries	14	Gain	24
AA Batteries and Transmitter Runtime	15	Cables	24
Alkaline Batteries	15	Interface Locks	24
Setting the AA Battery Type	15	Encryption Mismatch	25
Power Over USB	16	Firmware Mismatch	25
Menu Parameters	16	Tx Battery Hot	25
Tips for Editing Menu Parameters	16	Radio Frequency (RF)	25
Menu Map	17	Clean Battery Contacts	26
Menu Parameter Descriptions	17	Included Components	26
Radio Menu	17	Contact Customer Support	26
Audio Menu	18	Specifications	26

Frequency Range and Transmitter Output Level	29	Certifications	32
LICENSING INFORMATION	31	Information to the user	32
Australia Warning for Wireless	32		

ADX3 Plug-On Transmitter

ADX3 Plug-On Transmitter

Shure Axient Digital ADX series transmitters deliver impeccable audio quality and RF performance and are equipped with ShowLink® remote control for real-time parameter adjustments and interference avoidance. The Shure ADX3 plug-on transmitter transforms any microphone into an advanced Axient Digital ADX Series wireless microphone with wide-tuning, High Density (HD) mode, encryption, and advanced rechargeability. ADX3 features a patented locking mechanism for secure, wobble-free connection and supports both conventional AA and Shure SB900-series rechargeable batteries. The ADX3 is housed in a light-weight, rugged, metal chassis and is designed to resist sweat, moisture, and debris.



Important Safety Information

Explanation of Symbols -- Explication des symboles -- Erläuterungen zu Symbolen -- Explicación de los símbolos -- Spiegazione dei simboli -- Explicação dos Símbolos -- Объяснение обозначений -- Verklaring van symbolen -- シンボルの説明 -- 기호 설명 -- 符号说明 -- 符號說明 -- Penjelasan Simbol -- شرح الرموز

	<p>Caution: risk of electric shock</p> <p>Attention : risque de choc électrique</p> <p>Vorsicht: Stromschlagrisiko</p> <p>Precaución: riesgo de descarga eléctrica</p> <p>Attenzione: rischio di scosse elettriche</p> <p>Aviso: risco de choque elétrico</p> <p>Внимание: риск поражения электрическим током</p> <p>Waarschuwing: risico op elektrische schok</p> <p>警告：感電のおそれ</p> <p>주의: 전기 충격 위험</p> <p>小心电击</p> <p>注意：存在觸點風險</p> <p>Awas: risiko sengatan listrik</p> <p>تنبيه: خطر الصدمة الكهربائية</p>
	<p>Caution: risk of danger (See note.)</p>

	<p>Attention : risque de danger (voir la remarque)</p> <p>Vorsicht: Gefährdungsrisiko (siehe Hinweis.)</p> <p>Precaución: riesgo de peligro (ver nota)</p> <p>Attenzione: rischio di pericolo (vedi nota).</p> <p>Aviso: risco de perigo (Veja observação.)</p> <p>ВНИМАНИЕ: опасность (см. примечание.)</p> <p>Waarschuwing: risico op gevaar (zie opmerking)</p> <p>警告：危険のおそれ(注意書き参照)</p> <p>주의: 위험(주 참조)</p> <p>小心危険（参见注释）。</p> <p>注意：存在危険（参见注释）。</p> <p>Awas: risiko bahaya (Lihat catatan.)</p> <p>تنبيه: مخاطر الخطر (انظر الملاحظة)</p>
<p>==</p>	<p>Direct current</p> <p>Courant direct</p> <p>Gleichstrom</p> <p>Corriente directa</p> <p>Corrente continua</p> <p>Corrente direta</p> <p>Постоянный ток</p> <p>Gelijkstroom</p> <p>直流</p> <p>직류</p> <p>直流</p> <p>直流電</p> <p>Arus searah</p> <p>تيار مباشر</p>
<p>~</p>	<p>Alternating current</p> <p>Courant alternatif</p>

	<p>Wechselstrom</p> <p>Corriente alterna</p> <p>Corrente alternata</p> <p>Corrente alternada</p> <p>Переменный ток</p> <p>Wisselstroom</p> <p>交流</p> <p>교류</p> <p>交流</p> <p>交流電</p> <p>Arus bolak-balik</p> <p>تيار متناوب</p>
<p>I</p>	<p>On (Supply)</p> <p>Marche (alimentation)</p> <p>Ein (Versorgung)</p> <p>Encendido (alimentación)</p> <p>Alimentazione attiva</p> <p>Ligado (Fonte)</p> <p>Вкл. (питание)</p> <p>Aan (voeding)</p> <p>オン (供給)</p> <p>켜짐(공급장치)</p> <p>打开 (供电)</p> <p>開啟 (電源)</p> <p>Hidup (Catu)</p> <p>تشغيل (إمداد)</p>
<p>□</p>	<p>Equipment protected throughout by DOUBLE INSULATION or REINFORCED INSULATION</p> <p>Équipement intégralement protégé par une DOUBLE ISOLATION ou une ISOLATION RENFORCÉE</p>

	<p>Geräte durchgängig durch DOPPELTE ISOLIERUNG oder VERSTÄRKTE ISOLIERUNG geschützt</p> <p>El equipo está protegido con AISLAMIENTO DOBLE o AISLAMIENTO REFORZADO</p> <p>Apparecchio interamente protetto tramite ISOLAMENTO DOPPIO o ISOLAMENTO RINFORZATO</p> <p>Equipamento protegido por DUPLA ISOLAÇÃO ou ISOLAÇÃO REFORÇADA</p> <p>Оборудование защищено с использованием ДВОЙНОЙ ИЗОЛЯЦИИ или УСИЛЕННОЙ ИЗОЛЯЦИИ</p> <p>Apparatuur volledig beschermt door DUBBELE ISOLATIE of VERSTERKTE ISOLATIE</p> <p>二重絶縁または強化絶縁により常に保護されている機器</p> <p>이중 절연 또는 강화 절연으로 완전히 보호된 장비</p> <p>设备始终有双绝缘或加强绝缘保护</p> <p>透過雙絕緣或加強絕緣完全保護設備</p> <p>Peralatan dilindungi seluruhnya dengan ISOLASI GANDA atau ISOLASI DIPERKUAT</p> <p>الجهاز محمي من خلال عزل مزدوج أو عزل مقوى</p>
	<p>Stand-by</p> <p>Veille</p> <p>Standby</p> <p>En espera</p> <p>Standby</p> <p>Em espera</p> <p>Режим ожидания</p> <p>Stand-by</p> <p>スタンバイ</p> <p>대기</p> <p>待机</p> <p>待機</p> <p>Siaga</p> <p>وضع الاستعداد</p>
	<p>Equipment should not be disposed of in the normal waste stream</p>

Ne pas mettre l'équipement au rebut avec les déchets normaux

Geräte sollten nicht im normalen Abfallstrom entsorgt werden

No se debe desechar el equipo en el canal normal de eliminación de desechos

L'apparecchio non deve essere smaltito nel flusso dei rifiuti normali

Este equipamento não deve ser descartado em lixo comum

Оборудование не подлежит утилизации вместе с обычными бытовыми отходами

Apparatuur mag niet worden afgevoerd via het normale afvalstelsel

機器は通常の廃棄物の流れにより廃棄されてはなりません。

장비를 일반 쓰레기 수거함에 폐기하지 말 것

本设备不能作一般废弃物处理

不應在普通廢水中處理設備

Peralatan tidak boleh dibuang dalam aliran limbah normal

يجب عدم التخلص من الجهاز في جدول الفضلات الخطرة

IMPORTANT SAFETY INSTRUCTIONS

1. READ these instructions.
2. KEEP these instructions.
3. HEED all warnings.
4. FOLLOW all instructions.
5. DO NOT use this apparatus near water.
6. CLEAN ONLY with dry cloth.
7. DO NOT block any ventilation openings. Allow sufficient distances for adequate ventilation and install in accordance with the manufacturer's instructions.
8. DO NOT install near any heat sources such as open flames, radiators, heat registers, stoves, or other apparatus (including amplifiers) that produce heat. Do not place any open flame sources on the product.
9. DO NOT defeat the safety purpose of the polarized or grounding type plug. A polarized plug has two blades with one wider than the other. A grounding type plug has two blades and a third grounding prong. The wider blade or the third prong are provided for your safety. If the provided plug does not fit into your outlet, consult an electrician for replacement of the obsolete outlet.
10. PROTECT the power cord from being walked on or pinched, particularly at plugs, convenience receptacles, and the point where they exit from the apparatus.
11. ONLY USE attachments/accessories specified by the manufacturer.
12. USE only with a cart, stand, tripod, bracket, or table specified by the manufacturer, or sold with the apparatus. When a cart is used, use caution when moving the cart/apparatus combination to avoid injury from tip-over.





13. UNPLUG this apparatus during lightning storms or when unused for long periods of time.
14. REFER all servicing to qualified service personnel. Servicing is required when the apparatus has been damaged in any way, such as power supply cord or plug is damaged, liquid has been spilled or objects have fallen into the apparatus, the apparatus has been exposed to rain or moisture, does not operate normally, or has been dropped.
15. DO NOT expose the apparatus to dripping and splashing. DO NOT put objects filled with liquids, such as vases, on the apparatus.
16. The MAINS plug or an appliance coupler shall remain readily operable.
17. The airborne noise of the Apparatus does not exceed 70dB (A).
18. Apparatus with CLASS I construction shall be connected to a MAINS socket outlet with a protective earthing connection.
19. To reduce the risk of fire or electric shock, do not expose this apparatus to rain or moisture.
20. Do not attempt to modify this product. Doing so could result in personal injury and/or product failure.
21. Operate this product within its specified operating temperature range.

WARNING: Voltages in this equipment are hazardous to life. No user-serviceable parts inside. Refer all servicing to qualified service personnel. The safety certifications do not apply when the operating voltage is changed from the factory setting.

WARNING

- Battery packs may explode or release toxic materials. Risk of fire or burns. Do not open, crush, modify, disassemble, heat above 140°F (60°C), or incinerate.
- Follow instructions from manufacturer
- Only use Shure charger to recharge Shure rechargeable batteries
- **WARNING:** Danger of explosion if battery incorrectly replaced. Replace only with same or equivalent type.
- Never put batteries in mouth. If swallowed, contact your physician or local poison control center
- Do not short circuit; may cause burns or catch fire
- Do not charge or use battery packs other than Shure rechargeable batteries
- Dispose of battery packs properly. Check with local vendor for proper disposal of used battery packs.
- Batteries (battery pack or batteries installed) shall not be exposed to excessive heat such as sunshine, fire or the like
- Do not immerse the battery in liquid such as water, beverages, or other fluids.
- Do not attach or insert battery with polarity reversed.
- Keep away from small children.
- Do not use abnormal batteries.
- Pack the battery securely for transport.

	<p>WARNING</p> <p>If water or other foreign objects enter the inside of the device, fire or electric shock may result. Do not attempt to modify this product. Doing so could result in personal injury and/or product failure.</p>
	<p>CAUTION</p> <p>Never disassemble or modify the device, as failures may result. Do not subject to extreme force and do not pull on the cable or failures may result. Keep the microphone dry and avoid exposure to extreme temperatures and humidity.</p>

Note: Use only with the included power supply, batteries, or a Shure-approved equivalent.

Features

Performance

- 20 Hz to 20 kHz range with flat frequency response
- Automatic input staging optimizes gain setting
- AES 256-bit encryption-enabled for secure transmission
- >120 dB dynamic range
- 100 meter (300 feet) line-of-sight operating range
- Diversity ShowLink-enabled for remote transmitter control and automatic interference avoidance
- Selectable modulation modes optimize performance for spectral efficiency
 - Standard – optimal coverage, low latency
 - High density – dramatic increase in max system channel count
- Built-in tone generator and RF markers to facilitate walk-testing
- Switchable Power Levels = 2/10/35 mW (region dependent)

Design

- Locking XLR connector
- OLED display with easy-to-navigate menu and controls
- Rugged metal construction
- Menu and power lockout

Power

- Over 6 hours continuous use with Shure rechargeable battery
- Shure lithium-ion rechargeable battery provides extended battery life, precision metering, and zero memory effect
- External power and battery charging over USB-C

ADX3 Transmitter Overview

① Display

View menu screens and settings.

② Infrared (IR) port

Align with the receiver IR port during an IR Sync for automated transmitter tuning and setup.

③ Control buttons

Use to navigate through parameter menus and to change settings.

④ Power switch

Hold the X button to power the unit on or off.

⑤ Enter button

Press to enter menu screens and confirm menu changes.

⑥ Power LED

- Green = Unit is powered on
- Red = Low battery, or battery error

⑦ Audio LED

Red, yellow, and green LEDs indicate average and peak audio levels.

The LED will turn red when the limiter is engaged.

⑧ USB-C port

Supplies power or charges Shure rechargeable battery. LED indicates charging status when connected to a power supply.

- Red = Charging
- Green = Full charge
- Yellow = Not charging

⑨ Battery compartment

Requires two AA batteries or Shure rechargeable battery.

⑩ AA battery adapter

Use to secure AA batteries. Remove when using a Shure rechargeable battery.

⑪ XLR connector

Connection point for wired microphones, cables, and boom poles, among other things.

⑫ Locking ring

To release the XLR connector, turn the ring counterclockwise and push in.

⑬ Pouch

Provides additional grip and protection for the transmitter.

⑭ Belt clip

Holds transmitter and microphone securely for hands-free carrying.

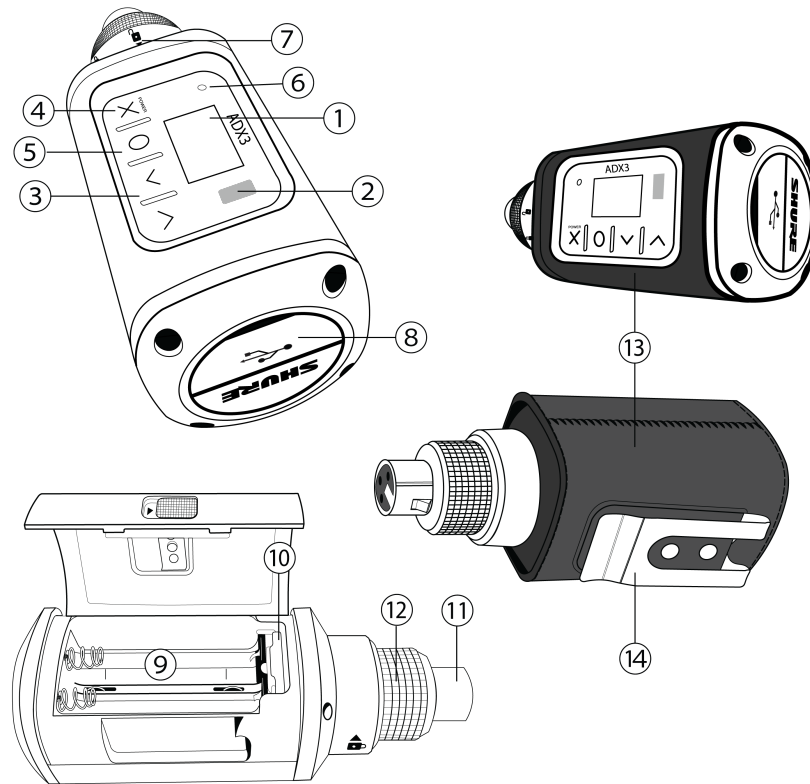

Setup

1. Slide the tab on the side of the transmitter to open the battery door.
2. Install the batteries.
 - **AA batteries:** Place batteries (note polarity markings) and AA adapter as shown below and close the door.
 - **Shure rechargeable battery:** Place battery as shown below (note polarity markings). Remove the AA adapter and close the door to secure the battery.

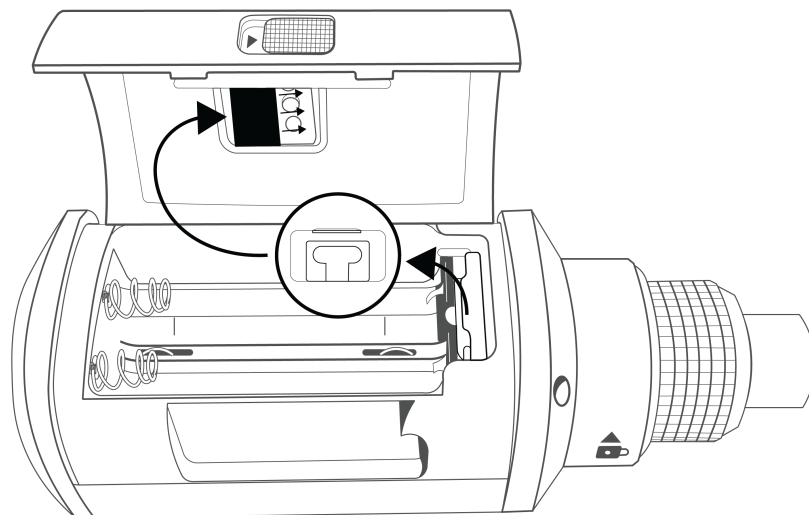

Note: If using AA batteries, set the battery type to ensure the transmitter's battery status indicator is accurate.

3. Press and hold X to turn on the transmitter.
4. Select the appropriate input pad or boost to avoid overloading the audio input or add boost to low-output sources: Audio > Pad / Boost
 - -12 dB: Use with high output sources, such as line levels and point-to-point applications.
 - Off (default): Use with typical microphones.
 - +12 dB: Use with low output sources.
5. Plug the transmitter into an XLR microphone or the output of an audio device.

Transmitter Controls

Use the controls to navigate menus and update settings.

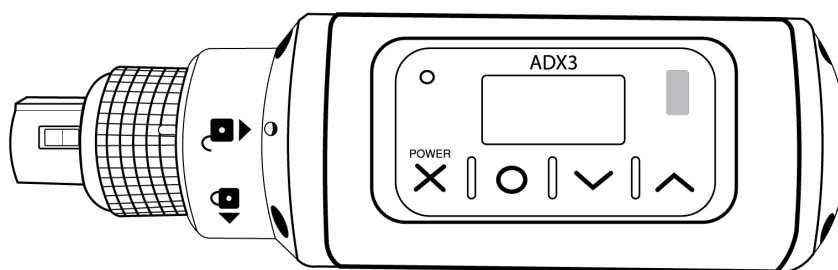

X	Hold button to turn transmitter power on and off. Acts as a 'back' button to return to previous menus or parameters without confirming a value change.
O	Enters menu screens and confirms parameter changes
V^	Use to scroll through menu screens and to change parameter values

Tip: Hold the \wedge button while powering on to enter safe start mode.

Shure Rechargeable Battery

Shure SB900B-series lithium-ion batteries offer a rechargeable option for powering the transmitters. Batteries charge to 50% capacity in 1 hour and reach full charge within 3 hours.

Single chargers and multiple bay chargers are available to recharge the Shure batteries. Shure rechargeable batteries can also be charged while inside the ADX3 if the ADX3 is connected to power over USB.

Caution: Only charge Shure rechargeable batteries with a Shure battery charger or while inserted into an ADX3 that is connected to power over USB.

Checking Battery Info

When using a Shure rechargeable battery, the receiver and transmitter home screens display the number of hours and minutes remaining.

Detailed information for the battery is displayed Battery menu of the transmitter: **Utilities > Battery**

- **Battery:** The chemistry type of for the installed battery (Shure, Alkaline, Lithium, NiMH)
- **Battery Time to Full** (only appears when Shure rechargeable battery is being externally charged): Time remaining until battery is fully charged
- **Battery Life:** Indicates remaining battery runtime
- **Charge:** Percentage of charge capacity
- **Health:** Percentage of current battery health
- **Cycle Count:** Total of the number of charging cycles for the installed battery
- **Temperature:** Battery temperature reported in Celsius and Fahrenheit

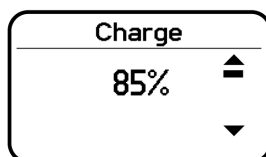

Shure SB900B-Series Runtime

10 mW	35 mW
6+ hours	4+ hours

Note: Phantom power, RF output and the impedance of the connecting device can impact battery life.

Important Tips for Care and Storage of Shure Rechargeable Batteries

Proper care and storage of Shure batteries results in reliable performance and ensures a long lifetime.

- Always store batteries and transmitters at room temperature
- Ideally, batteries should be charged to approximately 40% of capacity for long-term storage
- Periodically clean the battery contacts with alcohol to maintain ideal contact
- During storage, check batteries every 6 months and recharge to 40% of capacity as needed

For additional rechargeable battery information, visit www.shure.com.

Note: A Battery Hot warning indicates that transmitter battery needs to cool off. Otherwise, the transmitter will shut down. Let the device cool down and then consider swapping the transmitter battery to continue operation.

Identify any possible external heat sources to the transmitter and operate the transmitter away from those external heat sources.

All batteries should be stored and operated away from external heat sources in reasonable temperature conditions for best performance.





AA Batteries and Transmitter Runtime

Transmitters are compatible with the following AA battery types:

- Alkaline
- Nickel Metal Hydride (NiMH)
- Lithium Primary

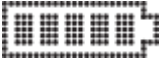
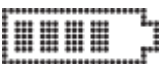
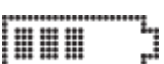
A 5-segment battery indicator representing the charge level of the transmitter battery is displayed on the screens of the transmitter and receiver. The following table contains the approximate remaining transmitter runtime in hours:minutes.

Alkaline Batteries

Battery Indicator	Battery Runtime (hours:minutes)			
	UHF		1.x	
	2 mW/10 mW	35 mW	2 mW /10 mW	30 mW
	8:00 to 6:00	3:30 to 3:00	5:30 to 4:15	3:45 to 3:00
	6:00 to 4:00	3:00 to 2:00	4:15 to 3:00	3:00 to 2:15
	4:00 to 1:45	2:00 to 1:30	3:00 to 1:45	2:15 to 2:00
	<1:45	<1:30	<1:45	<2:00
	<0:45	<0:45	<0:45	<0:45
	<0:15	<0:15	<0:15	<0:15

Setting the AA Battery Type

To ensure accurate display of transmitter runtime, set the battery type to match the battery you have installed.

Note: If a Shure rechargeable battery is installed, selecting a battery type is not necessary and the battery type will display Shure.

1. Navigate to Utilities and select Battery.
2. Use the ▼ ▲ buttons to select the installed battery type:
 - Alkaline = Alkaline
 - NiMH = Nickel Metal Hydride
 - Lithium = Lithium Primary
3. Press O to save.

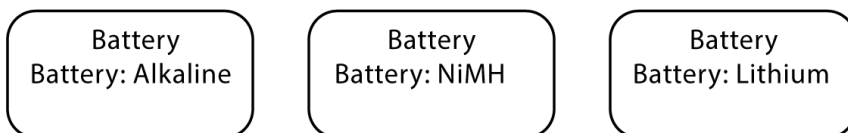

Power Over USB

When operated with AA batteries, or without batteries, the ADX3 transmitter can be powered by connecting the USB-C port on the bottom of the transmitter to a suitable power source.

When a Shure rechargeable battery is inserted, the USB connection can power the transmitter while simultaneously charging the battery.

Menu Parameters

The Main menu organizes the available transmitter parameters into three categories:

- Radio
- Audio
- Utilities

Tips for Editing Menu Parameters

- To access the menu options from the home screen, press O . Use the arrow buttons to access additional menus and parameters.
- A menu parameter will blink when editing is enabled
- To increase, decrease or change a parameter, use the arrow buttons
- To save a menu change, press O
- To exit a menu without saving a change, press X

Menu Map

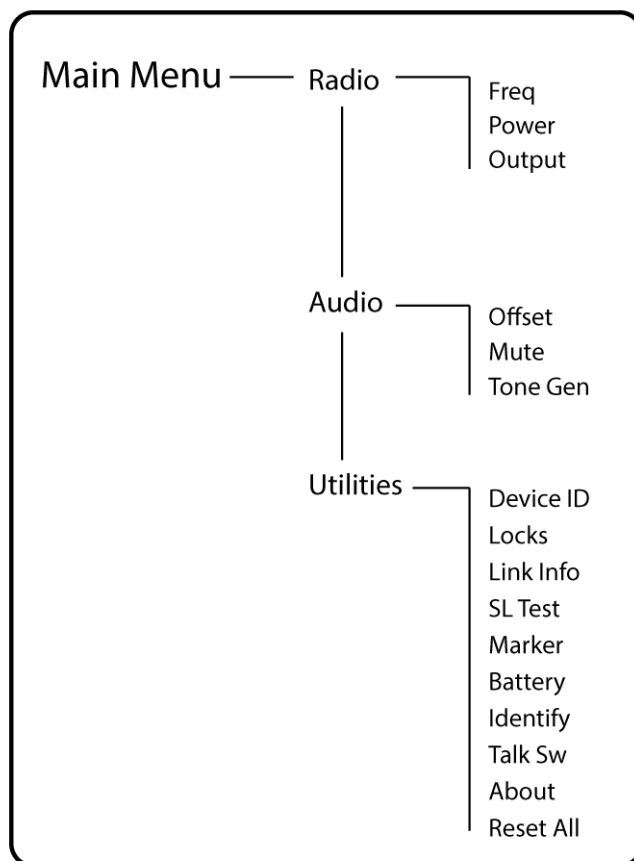

Menu Parameter Descriptions

Radio Menu

Freq

Press the enter button to enable editing of a group (G:) channel (C:) or frequency (MHz). Use the arrow buttons to adjust the values. To edit the frequency, press the O button once to edit the first 3 digits, or twice to edit the second 3 digits.

Power

Higher RF power settings can extend the range of the transmitter.

Note: Higher RF power settings decrease battery runtime.

Output

Sets the RF output to On or Mute.

- On: RF signal is active
- Mute: RF signal is inactive

Audio Menu

Offset

Adjust Offset level to balance mic levels when using two transmitters for frequency diversity or when assigning multiple transmitters to receiver slots. Adjustment range: -12 dB to +21 dB.

Mute

When enabled, the power switch is configured as a mute switch for the audio:

- Power switch on: audio signal on
- Power switch off: audio signal muted

Tone Gen

Transmitter will generate a continuous test tone:

- Freq: The tone can be set to 400 Hz or 1000 Hz.
- Level: Allows for adjustment of the output level of the test tone.

Utilities Menu

Device ID

Assign a device ID of up to 9 letters or numbers.

Locks

Locks the transmitter controls and power switch.

- None: The controls are unlocked
- Power: The power switch is locked
- Menu: The menu parameters are locked
- All: The power switch and menu parameters are locked

Link Info

Displays the following information about the link between a transmitter and receiver:

- Not Linked: The transmitter is not linked to a receiver
- Linked: The transmitter is linked to a receiver. Select Unlink? to free the transmitter from the receiver link.
- Unlinked: The transmitter is not linked to a receiver

SL Test

ShowLink test tool to measure the boundaries of ShowLink coverage.

Marker

When enabled, press the enter button to drop a marker in Wireless Workbench.

Battery

Displays battery information:

- Battery Life: Runtime reported in bar display and time (hours:minutes)
- Charge: Percentage of charge capacity
- Health: Percentage of current battery health

- Cycle Count: Total of the number of charging cycles for the installed battery
- Temperature: Battery temperature reported in Celsius and Fahrenheit

Talk Sw

Press ENTER to add control from a talk switch. Press the button on the talk switch twice to complete the link.

Identify

When enabled, Identify flashes the transmitter icon in Wireless Workbench Inventory or Monitor tabs.

About

Displays the following transmitter information:

- Model: Displays the model number
- Band: Displays the tuning band of the transmitter
- FW Version: Installed firmware
- HW Version: Hardware version
- Serial Num: Serial number

Reset All

Restores all transmitter parameters to factory settings.



Home Screen Display

The home screen shows transmitter information and status.

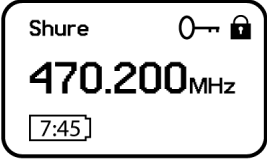
There are four pieces of information that you can choose to see on the home screen. Use the arrow buttons to select one of the following choices:

Name Frequency Setting Group (G) and Channel (C) Device ID	
---	--

The following icons indicate transmitter settings:

	Battery runtime in hours and minutes or bar display
	Key: Displayed when encryption is enabled
	Lock: Displayed when controls are locked. Icon flashes if you attempt to access a locked control (power or menu).
STD	STD: Standard Transmission Mode
HD	HD: High Density Transmission Mode

Locking the Interface

Lock transmitter interface controls to prevent accidental or unauthorized changes to parameters. The lock icon appears on the home screen when a lock is enabled.

- From the Utilities menu, navigate to Locks and select one of the following lock options:
 - None: The controls are unlocked.
 - Power: The device will remain on until locks are turned off or power runs out. Holding X will not turn the device off.
 - Menu: The menu parameters are locked.
 - All: Power and menu parameters are locked.
- Press O to save.

Tip: To quickly unlock the transmitter menu, press O and select None.

IR Sync

Use IR Sync to form an audio channel between the transmitter and receiver.

Note: The receiver band must match the band of the transmitter.

- Select a receiver channel.
- Tune the channel to an available frequency using group scan or manually turn to an open frequency.
- Power on the transmitter.
- Press the SYNC button on the receiver.
- Align the IR windows between the transmitter and the receiver so that the IR LED illuminates red. When complete, Sync Success! appears. The transmitter and receiver are now tuned to the same frequency.

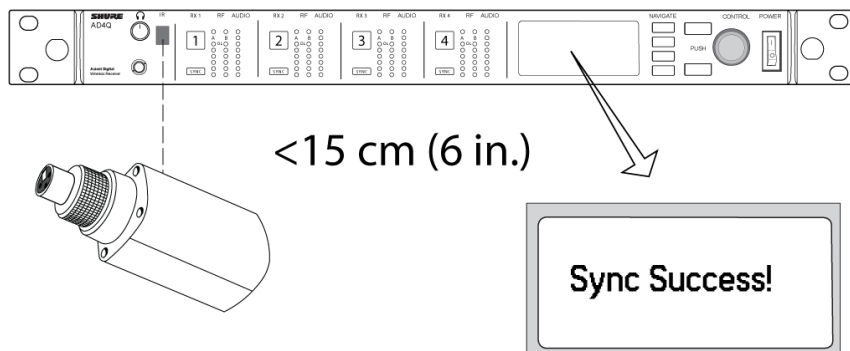

Note: Any change to the encryption status on the receiver (enabling/disabling encryption) requires a sync to send the settings to the transmitter. New encryption keys for the transmitter and receiver channel are generated on every IR sync, so to request a new key for a transmitter, perform an IR sync with the desired receiver channel.

Setting the Frequency Manually

The transmitter can be manually tuned to a specific group, channel, or frequency.

- Navigate to the Radio menu and select Freq.
- Scroll to select G: and C: to edit the group and channel, or select the frequency parameter (MHz). When editing the frequency, press O once to edit the first 3 digits, or twice to edit the last 3 digits.

3. Use the \wedge \vee buttons to adjust the group, channel, or frequency.
4. Press O to save, and then press X when finished.

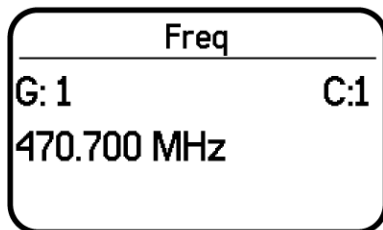

RF Mute

RF mute prevents transmission of the audio by suppressing the RF signal while the transmitter remains powered-on. The home screen displays RF Muted in this mode.

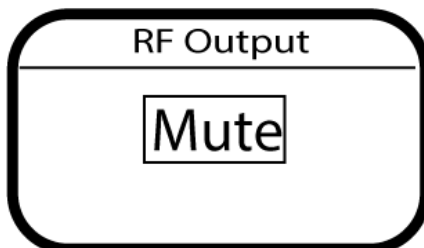

1. From the Radio menu, navigate to Output.
2. Choose one of the following options:
 - On: RF signal is active
 - Mute: RF signal is disabled
3. Press O to save.

Note: Turning the transmitter off and on or replacing the battery will restore Output to On.

Safe Start

Power on in safe start mode to prevent interference with other devices. Hold the \wedge button while powering on your device until the Safe Start menu appears.

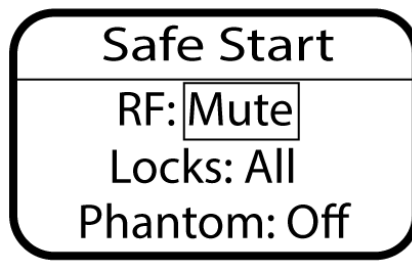

Safe Start menu options:

- RF: Mute or On
- Locks: None, Pwr, Menu, All
- Phantom: Off, +12V, +48V

Use the navigation buttons to make changes.

Tip: To exit the Safe Start menu, push X.

Note: Previous settings for locks, RF, and phantom power will be retained when the transmitter is powered on in safe start mode.

Input Overload

The Tx Overload message appears when the audio input experiences a high-level signal. The audio LED turns red as an additional indicator of an overload. Reduce the input signal or enable the input pad to remove the overload condition.

Tip: To enable the input pad, navigate to Audio > Pad and select -12 dB.

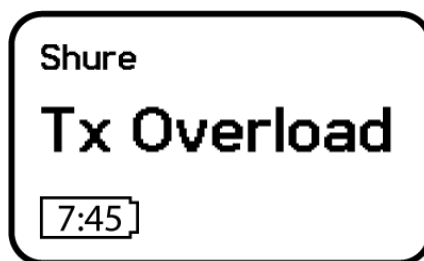

Tone Generator

The transmitter contains an internal tone generator that produces a continuous audio signal. The tone is helpful when conducting a sound check or for troubleshooting the audio signal chain. The level of the tone is adjustable from -60 dB to 0 dB and the frequency can be set to 400 Hz or 1000 Hz.

Tip: Always start with the level set to -60 dB to avoid overloading speakers or headphones.

1. From the Audio menu select Tone Gen.
2. Set the frequency to 400 Hz or 1000 Hz.
3. Select Level and use the arrow buttons adjust the value between -60 dB and 0 dB.

Turn off the tone by selecting Off from the menu or by cycling the transmitter power.

Tone Gen	
Tone:	400Hz
Level:	-60db

Matching Audio Levels with Offset

When linking two or more transmitters to a receiver, there may be a difference in volume levels between microphones or instruments. If this occurs, use the Offset function to match the audio levels and eliminate audible volume differences between transmitters. If using a single transmitter, set Offset to 0 dB.

1. Turn on the first transmitter and perform a sound check to test the audio level. Turn off the transmitter when finished.
2. Turn on the second transmitter and perform a sound check to test the audio level. Repeat for any additional transmitters.
3. If there is an audible difference in the sound level between the transmitters, navigate to the Offset menu (Audio > Offset) in the transmitter to increase or decrease the Offset in realtime to match the audio levels.

Audio Offset: +1dB

Updating Firmware

Firmware is embedded software in each component that controls functionality. Periodically, new versions of firmware are developed to incorporate additional features and enhancements. To take advantage of design improvements, you can upload and install new versions of the firmware by using the Shure Update Utility. The Shure Update Utility is available for download from <http://www.shure.com/>.

Firmware Versioning

When performing an update, first download firmware to the receiver, and then update transmitters to the same firmware version to ensure consistent operation.

The firmware numbering for Shure devices uses the following format: MAJOR.MINOR.PATCH.BUILD (e.g., 1.2.21.1). At a minimum, all devices on the network (including transmitters), must have the same MAJOR and MINOR firmware version numbers (e.g., 1.2.x).

Updating the Transmitter

1. Download the firmware to the receiver.
2. Access the following menu from the receiver: Device Settings > Tx Firmware Update.
3. Align the IR ports between the transmitter and the receiver. IR ports must be aligned for the entire download, which can take 50 seconds or longer.

Tip: The red alignment LED will turn on when the alignment is correct.

4. Press ENTER on the receiver to begin the download to the transmitter. The receiver will display the progress of the update as a percentage.

Troubleshooting

Issue	See Solution...
No sound	Power, Cables, Radio Frequency, or Encryption Mismatch
Faint sound or distortion	Gain, Cables
Lack of range, unwanted noise bursts, or dropouts	Radio Frequency (RF)
Cannot turn transmitter off or change frequency settings, or can't program receiver	Interface Locks
Encryption Mismatch message	Encryption Mismatch
Firmware Mismatch message	Firmware Mismatch
Transmitter Battery Hot message	Tx Battery Hot
Antenna Fault Red LED	RF
Handheld transmitter shuts down during use	Clean Battery Contacts

Power

Make sure that the receiver and transmitter are receiving sufficient voltage. Check the battery indicators and replace the transmitter batteries if necessary.

Gain

Adjust the system gain on the front of the receiver. Ensure the output level on the back of the receiver corresponds to the mic/line input setting of the mixing console, amplifier, or DSP.

Cables

Check that all cables and connectors are working correctly.

Interface Locks

The transmitter and the receiver can be locked to prevent accidental or unauthorized changes. A locked feature or button will produce the Locked screen on the LCD panel or the lock icon will flash on a transmitter.

Encryption Mismatch

Re-sync all receivers and transmitters after enabling or disabling encryption.

Firmware Mismatch

Paired transmitters and receivers must have the same firmware version installed to ensure consistent operation. See Firmware topic for firmware update procedure.

Tx Battery Hot

If the transmitter battery does not cool off, the transmitter will shut down. Let the device cool down and then consider swapping the transmitter battery to continue operation.

Identify any possible external heat sources to the transmitter and operate the transmitter away from those external heat sources.

All batteries should be stored and operated away from external heat sources in reasonable temperature conditions for best performance.

Radio Frequency (RF)

RF LEDs

If neither blue RF Diversity LED is illuminated, then the receiver is not detecting the presence of a transmitter.

The orange RF Signal Strength LEDs indicate the amount of RF power being received. This signal could be from the transmitter, **or it could be from an interfering source, such as a television broadcast**. If more than two of the orange RF LEDs are still illuminated while the transmitter is off, then that channel may be experiencing interference, and you should try a different channel.

The red RF LED indicates RF overload. Overloads have the potential to cause interference in multiple system installations. If you are experiencing an overload, turn off the receiver to see if it is causing interference with other components.

The numerical channel select button also turns red to indicate interference.

- Dim red = Channel is not selected, experiencing interference
- Bright red = Channel is selected, experiencing interference

Compatibility

- Perform a Scan and Sync to ensure the transmitter and receiver are set to the same group and channel.
- Look at the band label on the transmitter and make sure the receiver is set to the same band.

Reducing Interference

- Perform a group or channel scan to find the best open frequency. Perform a sync to transfer the setting to the transmitter.
- For multiple systems, check that all systems are set to channels in the same group (systems in different bands do not need to be set to the same group).
- Maintain a line of sight between transmitter and receiver antennas.
- Move or point receiver antennas away from metal objects or other sources of RF interference (such as LED walls, computers, digital effects, network switches, network cables and Personal Stereo Monitor (PSM) wireless systems).
- Eliminate RF overload (see below).

Increasing Range

If the transmitter is more than 6 to 60 m (20 to 200 ft) from the receiver antenna, you may be able to increase range by doing one of the following:

- Reduce interference (see above).
- Increase transmitter RF power level.
- Use Normal mode instead of High Density mode.
- Use an active directional antenna, antenna distribution system, or other antenna accessory to increase RF range.

Eliminating RF Overload

If you see the red RF LED on a receiver, try the following:

- Reduce the transmitter RF power level
- Move the transmitter further away from the receiver—at least 6 m (20 ft)
- If you are using active antennas, reduce antenna or amplifier gain.
- Use omnidirectional antennas

Antenna Faults

The Antenna Fault red LED indicates a short circuit condition or excessive load at an antenna port.

- Check antennas and cables for damage
- Ensure that antenna ports are not overloaded
- Check antenna bias voltage setting. Turn off voltage if using passive antennas.

Clean Battery Contacts

Clean the battery contacts with an electrical contact cleaner designed for gold contacts and safe on plastics.

Included Components

Shure rechargeable batteries (2)	SB900B or SB900B-A
USB-A to USB-C cable	95A39299
Zipper bag	95D2313
Pouch with belt clip	95A44910

Contact Customer Support

Didn't find what you need? [Contact our customer support](#) to get help.

Specifications

Mic Offset Range

-12 to 21 dB (in 1 dB steps)

Battery Type

Shure SB900B-series Rechargeable Li-Ion or LR6 AA batteries 1.5 V

Battery Runtime

@ 10 mW

Shure SB900B or SB900B-A	> 6 hours
alkaline	> 5 hours

Note: Phantom power, RF output and the impedance of the connecting device can impact battery life.

Dimensions

126 mm x 44.5 mm x 44.5 mm (5.0in. x 1.8in. x 1.8 in.) H x W x D

Weight

Without Battery	240 g (8.0 oz.),
with AA batteries	263 g
with Shure rechargeable battery	280 g

Housing

Cast Metal

Operating Temperature Range

-10°C (-14°F) to 50°C (122°F)

Note: Battery characteristics may limit this range.

Storage Temperature Range

-40°C (-40°F) to 74°C (165°F)

Note: Battery characteristics may limit this range.

Audio Input

Connector

3-pin female XLR

Configuration

balanced

Impedance

Pad-12 dB	26.64 k Ω
------------------	------------------

0 dB	6.64 k Ω
Boost12 dB	6.64 k Ω

Maximum Input Level

1 kHz at 1% THD

Pad-12 dB	21 dBV
0 dB	9 dBV
Boost12 dB	-3 dBV

Preamplifier Equivalent Input Noise (EIN)

System Gain Setting $\geq +20$

-115 dBV, A-weighted, typical

Phantom Power

+48 V(7 mA maximum) , +12 V(15 mA maximum)

High Pass Filter

Two-pole (12 dB per octave), cut off frequency selectable from 40 to 240 in 20 Hz increments

RF Output

Antenna Type

Dipole

Impedance

50 Ω

Occupied Bandwidth

<200 kHz

Channel-to-Channel Spacing

Standard Mode	350 kHz
High Density Mode	125 kHz

varies by region

Modulation Type

Shure Axient Digital Proprietary

Power

2 mW, 10 mW, 35 mW

See Frequency Range and Output Power table, varies by region

Specific Absorption Rate (SAR)

< 0.1 W/kg

ShowLink

Network Type

IEEE 802.15.4

Antenna Type

Dipole

Frequency Range

2.40 to 2.4835 GHz (16 Channels)

RF Output Power

10 dBm (ERP)

varies by region

Frequency Range and Transmitter Output Level

Band	Frequency Range (MHz)	RF Power (mW)***
G53	470 to 510	2/10/35
G54	479 to 565	2/10/20
G55†	470 to 636*	2/10/35
G56††	470 to 636	2/10/35
G57	470 to 616*	2/10/35
G62	510 to 530	2/10/35
G63	487 to 636	2/10
H54	520 to 636	2/10/35
K53	606 to 698*	2/10/35
K54 Δ	606 to 663**	2/10/35
K55	606 to 694	2/10/35
K56 ◇	606 to 714	2/10/35
K57 Δ	606 to 790	2/10/35
K58	622 to 698	2/10/35
L54	630 to 698	2/10/35
L60	630.125 to 697.875	2/10/35
P55	694 to 703, 748 to 758, 803 to 806	2/10/35
R52	794 to 806	2/10

Band	Frequency Range (MHz)	RF Power (mW) ^{***}
JB	806 to 810	2/10
X51	925 to 937.5	2/10
X55	941 to 960	2/10/35
X56†††	960 to 1000	2/10/35

*With a gap between 608 to 614 MHz.

**With a gap between 608 to 614 MHz and a gap between 616 to 653 MHz.

***Power delivered to the antenna port.

†Operation mode varies according to region. In Brazil, High Density mode is used. The maximum power level for Peru is 10mW.

††Limited to 10mW for Vietnam.

†††Only in UK; F-variant only.

△ Output power limited to 10 mW above 608 MHz.

◇ Korea defines power as conducted (ERP) which is 1dB less than declared in table.

NCC Notice

低功率射頻器材技術規範

取得審驗證明之低功率射頻器材，非經核准，公司、商號或使用者均不得擅自變更頻率、加大功率或變更原設計之特性及功能。低功率射頻器材之使用不得影響飛航安全及干擾合法通信；經發現有干擾現象時，應立即停用，並改善至無干擾時方得繼續使用。前述合法通信，指依電信管理法規定作業之無線電通信。低功率射頻器材須忍受合法通信或工業、科學及醫療用電波輻射性電機設備之干擾。

NBTC Notice

เครื่องโทรคมนาคมและอุปกรณ์นี้มีความสอดคล้องตามมาตรฐานหรือข้อกำหนดทางเทคนิคของ กสทช.

K55 606-694 MHz

Country Code Code de Pays Codice di paese Código de país Länder-Kürzel	Frequency Range Gamme de frequences Gamme di frequenza Gama de frecuencias Frequenzbereich
A, B, BG, CH, CY, CZ, D, DK, EST, F	*
FIN, GB, GR, H, HR, I, IRL, IS, L, LT	*
M, N, NL, P, PL, RO, S, SK, SLO, TR	*
all other countries	*

* This equipment may be capable of operating on some frequencies not authorized in your region. See [Licensing Information](#).

G56 470-636 MHz

Country Code	Frequency Range
Code de Pays	Gamme de frequences
Codice di paese	Gamme di frequenza
Código de país	Gama de frecuencias
Länder-Kürzel	Frequenzbereich
A, B, BG, CH, CY, CZ, D, DK, EST, F	*
FIN, GB, GR, H, HR, I, IRL, IS, L, LT	*
M, N, NL, P, PL, RO, S, SK, SLO, TR	*
all other countries	*

* This equipment may be capable of operating on some frequencies not authorized in your region. See [Licensing Information](#).

K57 606-790 MHz

Country Code	Frequency Range
Code de Pays	Gamme de frequences
Codice di paese	Gamme di frequenza
Código de país	Gama de frecuencias
Länder-Kürzel	Frequenzbereich
A, B, BG, CH, CY, CZ, D, DK, EST, F	*
FIN, GB, GR, H, HR, I, IRL, IS, L, LT	*
M, N, NL, P, PL, RO, S, SK, SLO, TR	*
all other countries	*

* This equipment may be capable of operating on some frequencies not authorized in your region. See [Licensing Information](#).

LICENSING INFORMATION

Licensing: A ministerial license to operate this equipment may be required in certain areas. Consult your national authority for possible requirements. Changes or modifications not expressly approved by Shure Incorporated could void your authority to operate the equipment. Licensing of Shure wireless microphone equipment is the user's responsibility, and licensability depends on the user's classification and application, and on the selected frequency. Shure strongly urges the user to contact the appropriate telecommunications authority concerning proper licensing, and before choosing and ordering frequencies.

Australia Warning for Wireless

WARNING: This device operates under an ACMA class licence and must comply with all the conditions of that licence including operating frequencies.

No user-operated control of power, frequency, or other parameters are available beyond those specified in this operating manual.

Please follow your regional recycling scheme for batteries, packaging, and electronic waste.

Certifications

Certified under FCC Part 15 and FCC Part 74.

Certified by ISED in Canada under RSS-210.

FCC ID: DD4AD3G57, DD4AD3K54, DD4AD3X55. **IC:** 616A-AD3G57, 616A-AD3K54.

Meets essential requirements of the following European Directives:

- WEEE Directive 2012/19/EU, as amended by 2008/34/EC
- RoHS Directive EU 2015/863

Note: Please follow your regional recycling scheme for batteries and electronic waste

This product meets the Essential Requirements of all relevant European directives and is eligible for CE marking.

CE Notice

Hereby, Shure Incorporated declares that this product with CE Marking has been determined to be in compliance with European Union requirements.

The full text of the EU declaration of conformity is available at the following site: <https://www.shure.com/en-EU/support/declarations-of-conformity>.

SRRC Notice

- (一) 本产品符合“微功率短距离无线电发射设备目录和技术要求”的具体条款和使用场景；
- (二) 不得擅自改变使用场景或使用条件、扩大发射频率范围、加大发射功率（包括额外加装射频功率放大器），不得擅自更改发射天线；
- (三) 不得对其他合法的无线电台（站）产生有害干扰，也不得提出免受有害干扰保护；
- (四) 应当承受辐射射频能量的工业、科学及医疗（ISM）应用设备的干扰或其他合法的无线电台（站）干扰；
- (五) 如对其他合法的无线电台（站）产生有害干扰时，应立即停止使用，并采取措施消除干扰后方可继续使用；
- (六) 在航空器内和依据法律法规、国家有关规定、标准划设的射电天文台、气象雷达站、卫星地球站（含测控、测距、接收、导航站）等军民用无线电台（站）、机场等的电磁环境保护区域内使用微功率设备，应当遵守电磁环境保护及相关行业主管部门的规定。

Information to the user

This equipment has been tested and found to comply with the limits for a Class B digital device, pursuant to part 15 of the FCC Rules. This equipment generates, uses, and can radiate radio frequency energy and, if not installed and used in accordance with the manufacturer's instruction manual, may cause interference with radio and television reception.

Notice: The FCC regulations provide that changes or modifications not expressly approved by Shure Incorporated could void your authority to operate this equipment.

These limits are designed to provide reasonable protection against harmful interference in a residential installation. This equipment generates, uses, and can radiate radio frequency energy and, if not installed and used in accordance with the instructions, may cause harmful interference to radio communications. However, there is no guarantee that interference will not occur in a particular installation. If this equipment does cause harmful interference to radio or television reception, which can be determined by turning the equipment off and on, the user is encouraged to try to correct the interference by one or more of the following measures:

- Reorient or relocate the receiving antenna.
- Increase the separation between the equipment and the receiver.
- Connect the equipment to an outlet on a circuit different from that to which the receiver is connected.
- Consult the dealer or an experienced radio/TV technician for help.

This device complies with part 15 of the FCC Rules. Operation is subject to the following two conditions:

1. This device may not cause harmful interference.
2. This device must accept any interference received, including interference that may cause undesired operation.

Canada Warning for Wireless

This device operates on a no-protection, no-interference basis. Should the user seek to obtain protection from other radio services operating in the same TV bands, a radio licence is required. For further details, consult Innovation, Science and Economic Development Canada's document Client Procedures Circular CPC-2-1-28, Voluntary Licensing of Licence-Exempt Low-Power Radio Apparatus in the TV Bands.

Ce dispositif fonctionne selon un régime de non-brouillage et de non-protection. Si l'utilisateur devait chercher à obtenir une certaine protection contre d'autres services radio fonctionnant dans les mêmes bandes de télévision, une licence radio serait requise. Pour en savoir plus, veuillez consulter la Circulaire des procédures concernant les clients CPC.2.1.28, Délivrance de licences sur une base volontaire pour les appareils radio de faible puissance exempts de licence et exploités dans les bandes de télévision d'Innovation, Sciences et Développement économique Canada.

This device operates on frequencies shared with other devices. Consult the Federal Communications Commission White Space Database Administration website to determine available channels in your area prior to operation.

Industry Canada (IC) Notices

This device contains licence-exempt transmitter(s)/receiver(s) that comply with Innovation, Science and Economic Development Canada's licence-exempt RSS(s). Operation is subject to the following two conditions:

1. This device may not cause interference.
2. This device must accept any interference, including interference that may cause undesired operation of the device.

L'émetteur/récepteur exempt de licence contenu dans le présent appareil est conforme aux CNR d'Innovation, Sciences et Développement économique Canada applicables aux appareils radio exempts de licence. L'exploitation est autorisée aux deux conditions suivantes :

1. L'appareil ne doit pas produire de brouillage;
2. L'appareil doit accepter tout brouillage radioélectrique subi, même si le brouillage est susceptible d'en compromettre le fonctionnement.