

48-789 TELEGARTNER BNC 3G HD Male cable, crimp, 75 ohm, group Z

48-779 TELEGARTNER BNC 3G HD Male cable, crimp, 75 ohm, group Z (pack of 100)

Mechanical Characteristics:

Cable Group:	Canford	Z	Telegartner	G48
Interface dimensions acc. to	IEC 61169-8			
Mating life	>500			

Materials

Centre contact	CuZn39Pb3
Outer contact	CuZn39Pb3
Other metal parts	GD-ZnAl4Cu1
Crimp ferrule	SF Cu w
Isulator	PTFE Green
Gasket	NBR

Finish

Cu1Ni2Au0.8
Cu2Ni5
Zn/Cu6Ni6
Ni5

Electrical characteristics:

Impedance	75 Ω
Frequency	0-3 GHz
Typical return loss (cable dependent)	1 GHz 36 dB 2 GHz 31 dB 3 GHz 29 dB
Working voltage	≤ 0.5 kVeff / 50 Hz
Voltage proof	1.5 kVeff / 50 Hz
Insulation resistance	≥ 5 GΩ
Centre contact resistance	≤ 20 mΩ
Outer contact resistance	≤ 5 mΩ

Environmental:

Operating temperature	-30°C to +75°C
RoHS compliant	2011/65/EC

Cable Prep:

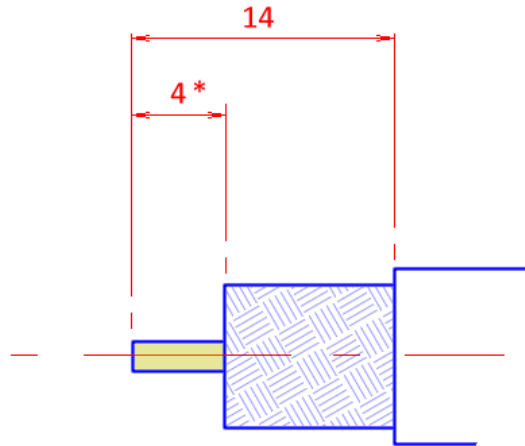

All dims: mm

Not to scale

* If foil screen present cut even with braid

Crimp Details:

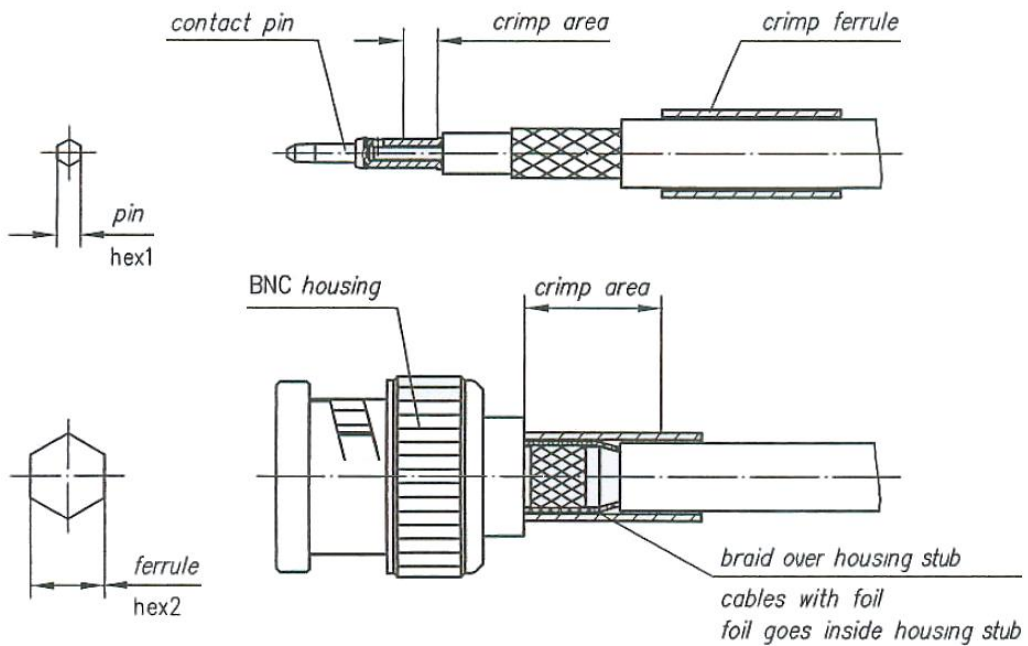

Hex1	Pin	2.54
Hex2	Ferrule	10.09

Tooling:

55-752 PALADIN 8000 Coaxial crimp tool
 55-765 PALADIN 3704 DIE SET for group Z and Telegartner BNC HD groups J, Z

Handset and die sold as singular item:

55-3222 CANFORD COAXIAL CRIMP TOOL Red, for Telegartner BNC, cable groups J, Z