

# ZOOM®

# P4

## PodTrak

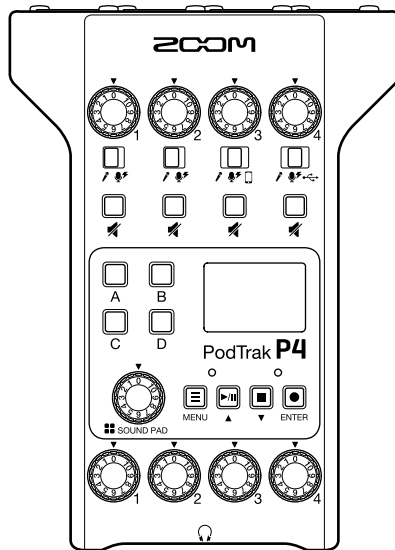

## Quick Guide

You must read the Usage and Safety Precautions before use.



The Operation Manual can be downloaded from the ZOOM website ([www.zoom.jp/docs/p4](http://www.zoom.jp/docs/p4)). This page has files in PDF and ePub formats.

The PDF file format is suitable for printing on paper and reading on a computer.

The ePub format can be read with electronic document readers and is designed for reading on smartphones and tablets.

© 2020 ZOOM CORPORATION

Copying or reprinting this manual in part or in whole without permission is prohibited.

Product names, registered trademarks and company names in this document are the property of their respective companies. All trademarks and registered trademarks in this document are for identification purposes only and are not intended to infringe on the copyrights of their respective owners.

You might need this manual in the future. Always keep it in a place where you can access it easily.





The contents of this manual and the specifications of the product could be changed without notice.

# Functions of parts

## ■ Top/Back/Front

### INPUT SELECT switches 1-4

Set these according to the connected equipment.

-  Dynamic mic
-  Condenser mic (supplies +48 V phantom power)
-  Smartphone, etc.
-  USB audio return signal output from computer

### SOUND PAD A-D

Use these to play the sounds assigned to them.

### SOUND PAD knob

Use to adjust SOUND PAD volumes.

### PHONES knobs 1-4

Use to adjust the volumes of signals output from PHONES jacks 1-4.

### Input jacks 1-4

These input jacks have built-in mic preamps.

### PHONES jacks 1-4

These output the signals adjusted by PHONES knobs 1-4.

### INPUT knobs 1-4

Use to adjust input signal levels.

### MUTE buttons 1-4

Use to mute (lit) and unmute (unlit) signals.

### Display

This shows the recorder status and MENU screen.

### PLAY indicator

This lights during playback and blinks when paused.

### REC indicator

This lights during recording and blinks when recording is paused.

### MENU button

Use to open the MENU screen and to return to the previous screen.

### PLAY/PAUSE/ ↑ button

Use to play/pause recorded files.  
Use to move the cursor up in the MENU screen.

### STOP/ ↓ button

Use to stop recording/playback.  
Use to move the cursor down in the MENU screen.

### REC/ENTER button

Use to start/stop recording.  
Use to confirm a selection in the MENU screen.

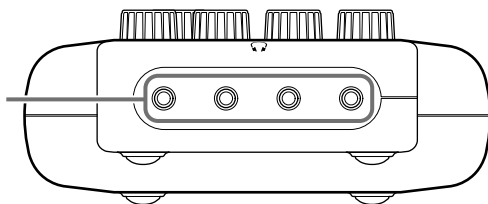
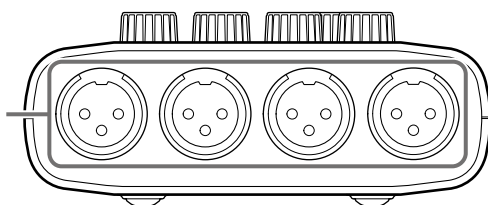
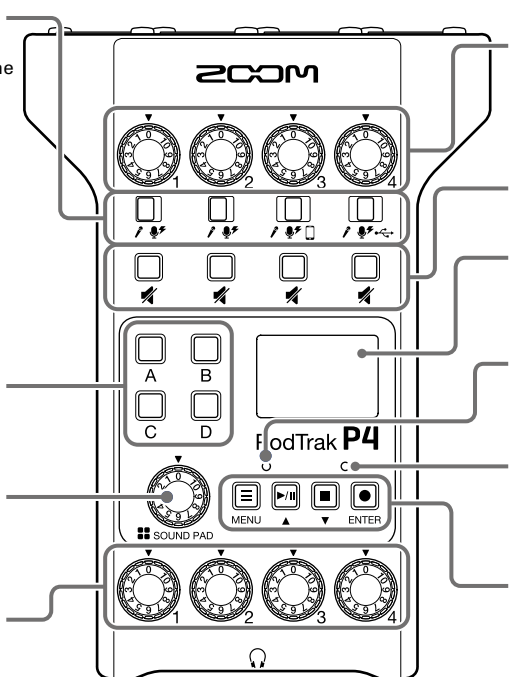

## ■ Left/Right

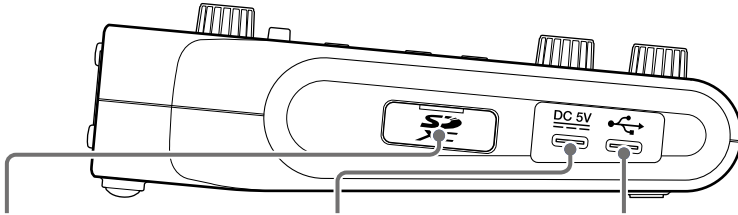

### SD card slot

Cards that conform to SDHC and SDXC specifications are supported. Format the SD card with the **P4** before use.

### Power supply USB Type-C port

This power supply USB port is for connecting an AC adapter or portable battery.

### USB Type-C port

This USB port is for connecting with a computer, smartphone or tablet.

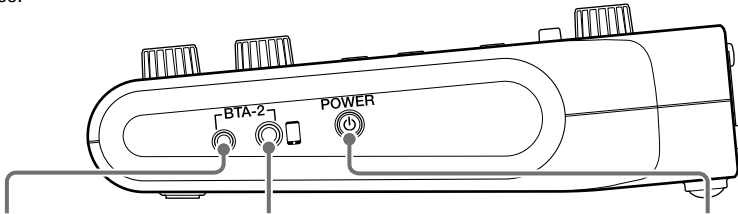

### Power supply connector for BTA-2

Use this power supply connector when connecting a BTA-2 wireless adapter.

### Smartphone connection jack

By using a 4-contact mini-plug cable, the signal from a smartphone can be input on channel 3 while the signal mixed on the **P4** (excluding the channel 3 signal) is returned to the smartphone simultaneously.

### POWER switch

Use to turn the power on and off.

## Installing batteries

To run the **P4** on battery power, open the battery compartment cover on the bottom and install two AA batteries.

Open while pressing down.

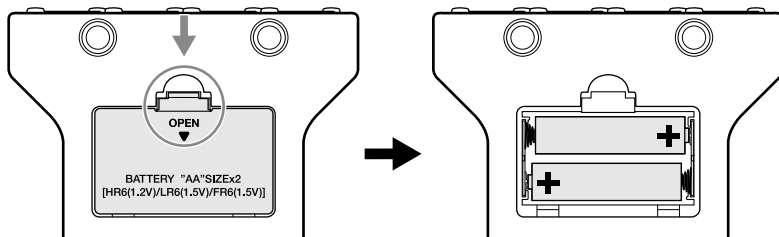

### NOTE

- Use only one type of battery (alkaline, NiMH or lithium) at a time.
- Set the type of battery used correctly so that the amount of remaining battery charge can be shown accurately. (→ page 15)
- The battery charge can be checked on the Home Screen.

# Connection examples

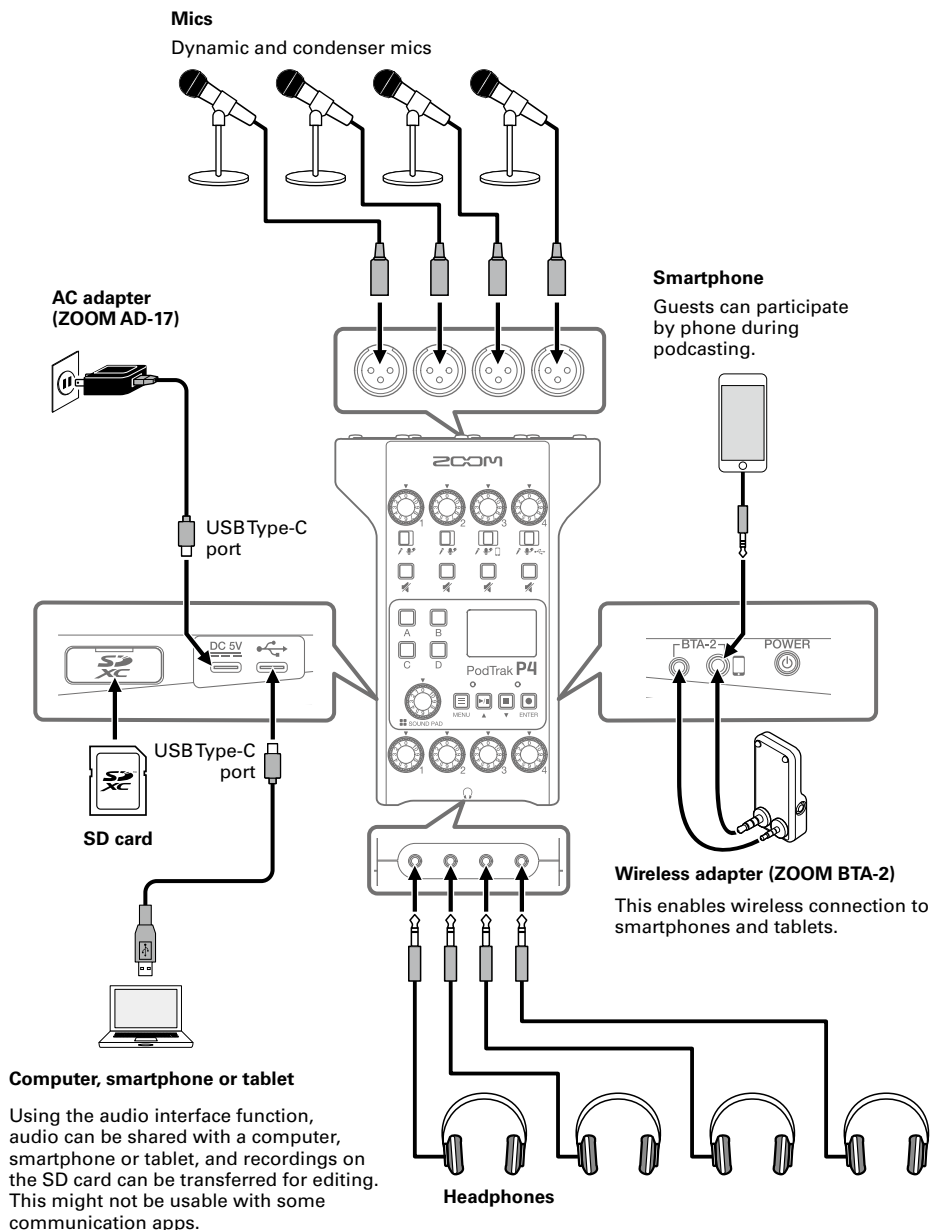

## Use examples

### ■ Using on location

By using the **P4** with batteries or a portable battery, audio can be recorded on location. The recorded audio is saved on an SD card and can be transferred to a computer for editing and distribution.



### ■ Using for live streaming

By connecting a **P4** to a computer, you can use it to stream audio in real time.



# Explanation of terms

## USB audio return

When the **P4** is connected as an audio interface, this is the signal output from the computer. Background music can be played from a computer during podcasting.

## SOUND PAD buttons

Audio files can be assigned to these. Press one to play the assigned file. These are convenient to play opening and closing music as well as interviews that have been recorded in advance.

## USB Mix Minus

When using the **P4** as an audio interface, signals input by USB can be set to not be output back to USB. When recording while calling through the computer, this can prevent feedback to the person at the other end.

# Signal flow

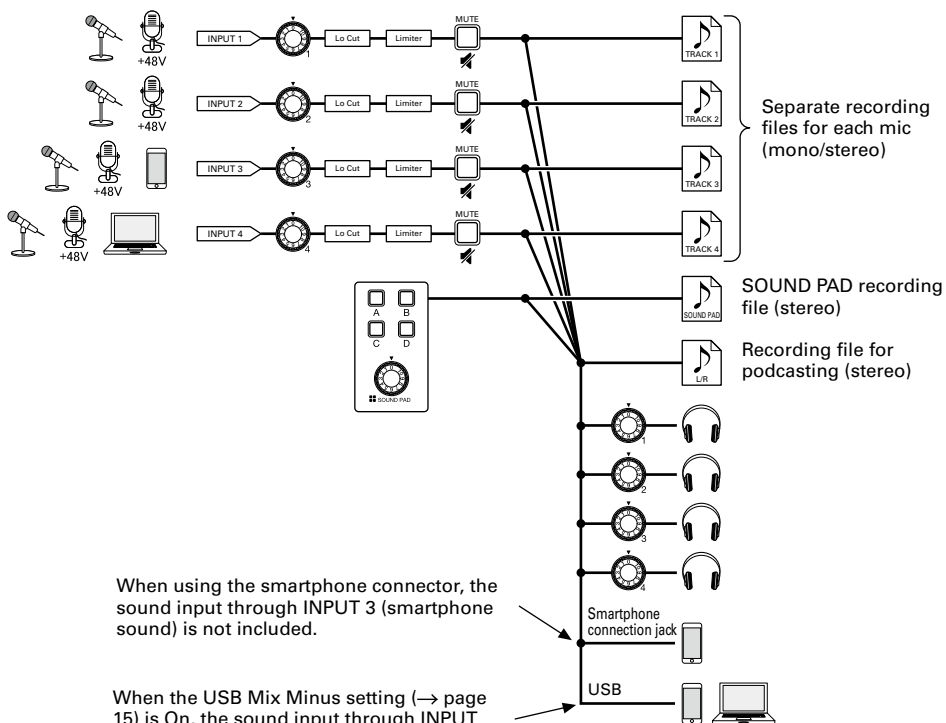

## Home Screen

This screen appears on the display when the **P4** power is turned on. This shows the **P4** conditions, including recording status and input levels.

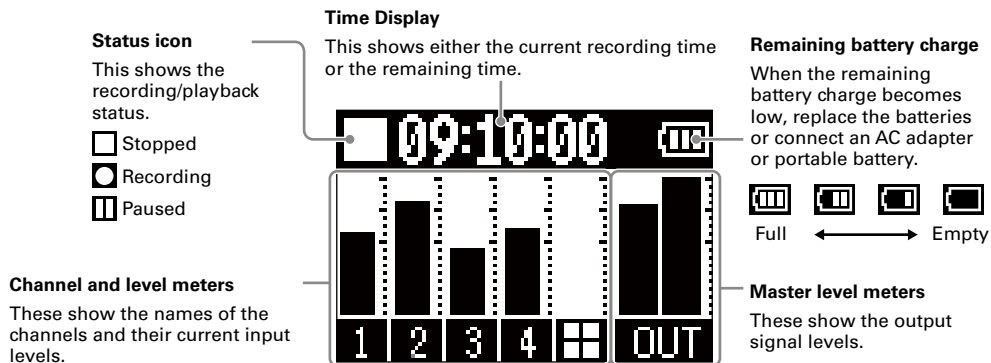

## Basic MENU operations

Use the MENU screen to make settings, including for recording and the SOUND PAD buttons.

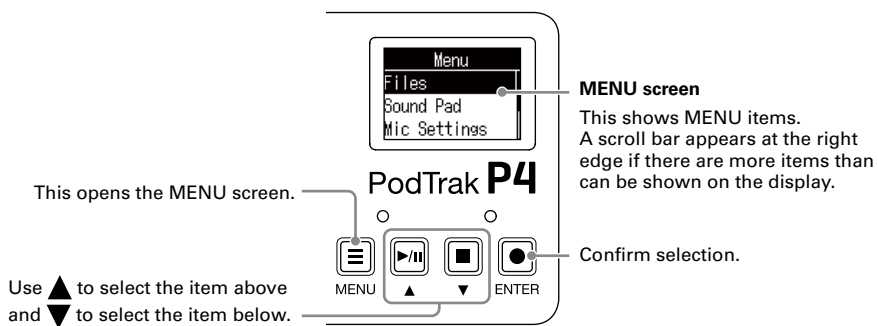

In this Quick Guide, MENU item names are shown with gray backgrounds, and the procedure of selecting items on the MENU screen using **▲**, **▼**, and **ENTER** is abbreviated as follows.

Procedure example: Select **Settings** on the MENU screen

Example of explanation in "Other functions and settings": MENU screen > **Settings** > **Battery**

### HINT

- Press **MENU** to return to the previous screen.
- To return to the Home Screen, press **MENU** repeatedly until it appears.

# Making preparations

## ■ Inserting SD cards

With the power off, open the SD card slot cover, and insert an SD card all the way into the slot.

To remove an SD card, push it further into the slot and then pull it out.

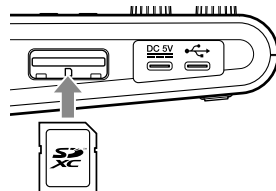

### NOTE

- Disable write-protection on the SD card before inserting it.
- Inserting or removing an SD card while the power is on could result in data loss.
- When inserting an SD card, be sure to insert the correct end with the top side up as shown.
- If an SD card is not loaded, recording and playback are not possible.
- Before using SD cards that have just been purchased or that have been formatted on a computer, they must be formatted by the **P4** (→ page 15).

## ■ Turning the power on

1. Press  until "ZOOM" appears on the display.

This turns the power on and opens the Home Screen.

To turn the power off, press  until "Goodbye! See You!" appears on the display.

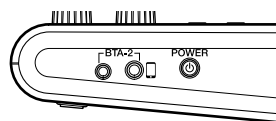



### NOTE

The power will automatically turn off if it is not used for 10 hours. To keep the power on at all times, set the Auto Power Off function to **Off** (→ page 15).

### HINT

Operation is possible using power supplied from the power supply USB port by connecting a dedicated AC adapter (ZOOM AD-17) or portable battery to it.

## ■ Setting the date and time

The first time the power is turned on after purchase, the Set Date/Time screen appears on the display. Use  /  /  to select the year, month, day, hour or minute,

use  /  to change its values, and use  to confirm it. Then, repeat for each item.

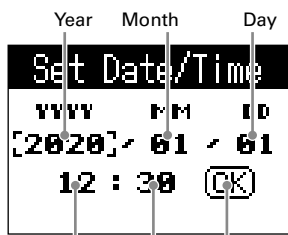

### HINT

The date and time setting can be changed later using MENU screen > Settings > Set Date/Time.

Hour Minute Confirm the date and time.



## ■ Connecting mics

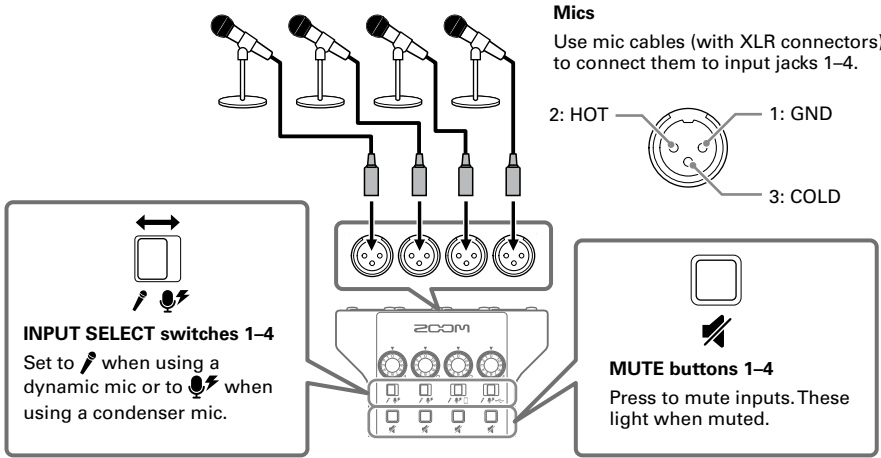

### NOTE

When an INPUT SELECT switch is set to , +48 V phantom power is supplied to that input jack. When connecting a device that is not compatible with phantom power, do not set the INPUT SELECT switch to . Doing so could damage the device.

## ■ Connecting headphones

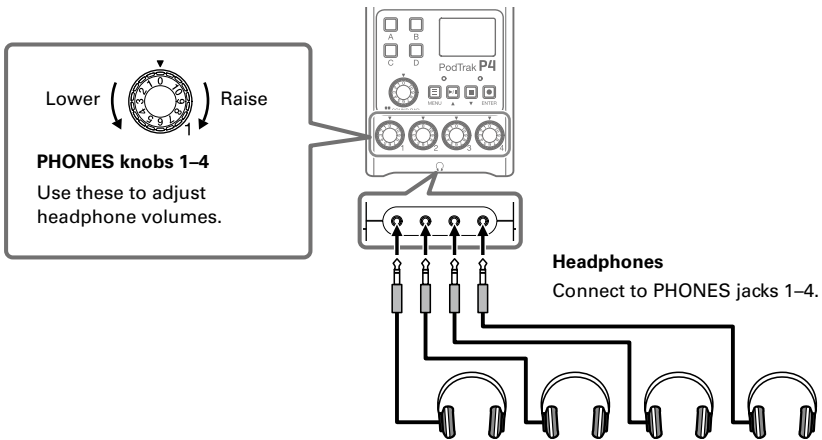

## ■ Connecting smartphones

When podcasting, the voice of a guest participating by phone can be input on channel 3. By using a 4-contact mini-plug cable, a signal can be input from a smartphone and a mono signal can be sent back to it simultaneously. Since this output signal does not include the sound from channel 3, guests participating by phone will not have an echo.

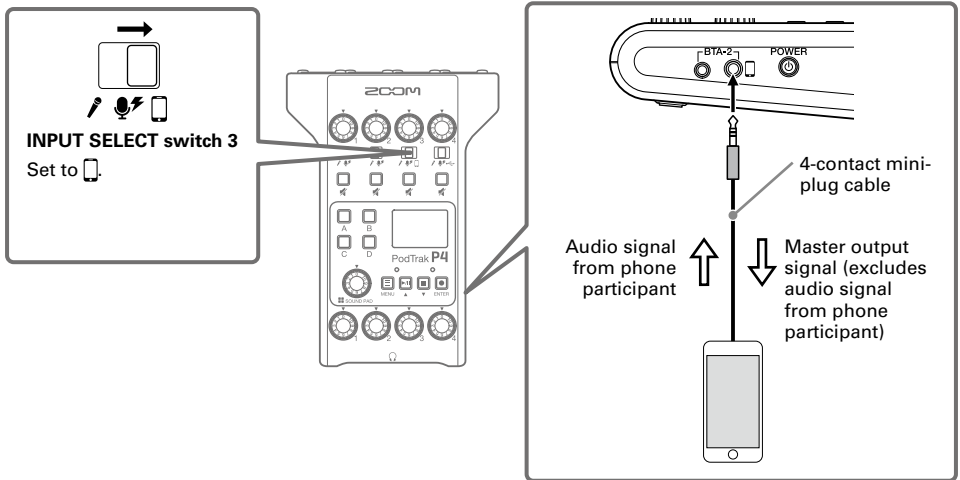

## ■ Connecting a computer, smartphone or tablet by USB

Using the audio interface function (→ page 15), music, interviews and other audio played back on a computer, smartphone or tablet can be input through channel 4. Sound input through the **P4** and sound played with SOUND PAD buttons can also be streamed live directly. Recording files on SD cards can also be transferred for editing. (→ page 13)

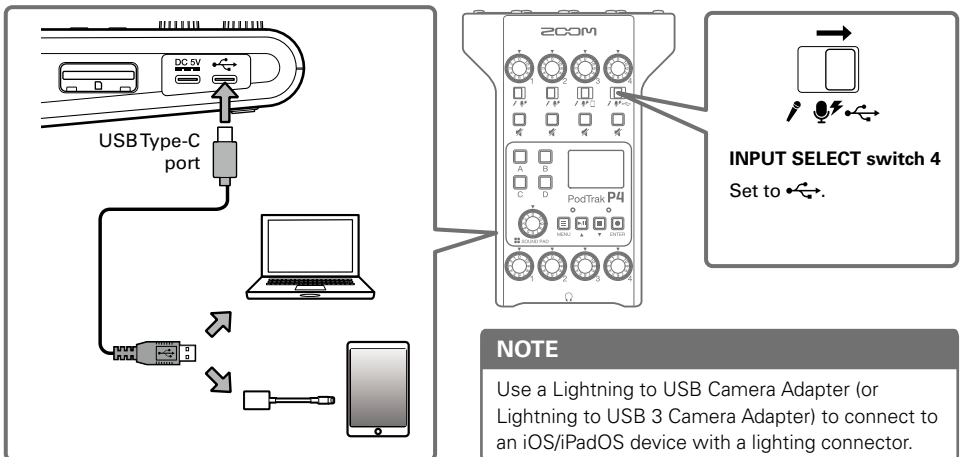

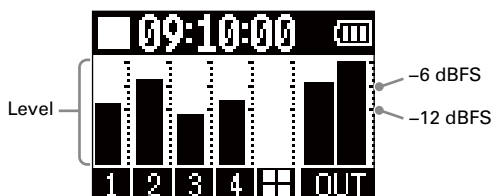
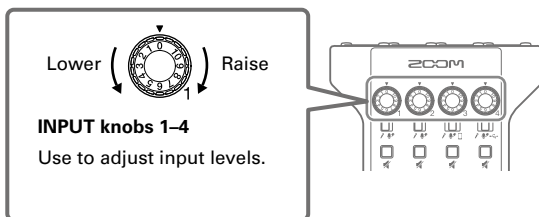

# Recording

## ■ Adjusting input levels



Input levels are shown on the display. Adjust the levels so that they are between  $-12$  dBFS and  $-6$  dBFS.

### HINT

When smartphone or USB audio return signals are being input (INPUT SELECT switches are set to  or ), the input will be in stereo and stereo level meters will be shown.

## ■ Making mic settings (Mic Settings)

The Lo Cut and Limiter functions can be turned on/off for each input.

The factory default setting is on for all.

1. Select **Mic Settings** on the MENU screen.
2. Select a setting
  - **Lo Cut**: This can cut low frequencies to reduce the sound of air conditioning, wind, vocal pops and other noise.
  - **Limiter**: This can prevent distortion by reducing input signals that have excessively high levels.
3. Select the mic (**Mic 1–Mic 4**) for which you want to turn this function on.  
The Lo Cut or Limiter setting is on for the mics that have check marks.

| Lo Cut |                                     |
|--------|-------------------------------------|
| Mic 1  | <input checked="" type="checkbox"/> |
| Mic 2  | <input type="checkbox"/>            |
| Mic 3  | <input type="checkbox"/>            |



| Limiter |                                     |
|---------|-------------------------------------|
| Mic 1   | <input type="checkbox"/>            |
| Mic 2   | <input checked="" type="checkbox"/> |
| Mic 3   | <input checked="" type="checkbox"/> |

## ■ Recording

The input signals of each channel, the sounds (stereo) played by pressing SOUND PAD buttons, and the master channel signal (stereo) can be recorded simultaneously as separate files to the SD card.

1. Press  when the Home Screen is open.

Recording will start and the REC indicator with light red.



Press  when recording to pause recording (REC indicator will blink). Press  again to resume recording.

2. Press  or .

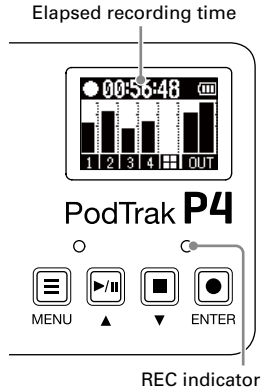
Recording will stop.



### HINT





- When the channel 3 INPUT SELECT switch is set to  or the channel 4 INPUT SELECT switch is set to , those channels will record in stereo.
- If you do not want to record a channel or you want to turn its input off temporarily, press  to mute it.

## Playing recordings

Recorded files can be played back.

1. Press  when the Home Screen is open.

The most recently recorded file will start playing and the PLAY indicator will light green.

- Pause: Press  to start/pause playback alternately.
- Search backward: Press and hold .
- Search forward: Press and hold .
- Cue: Press  to return to the beginning of the file.
- Stop playback: Press  to stop playback and return to the HOME Screen.

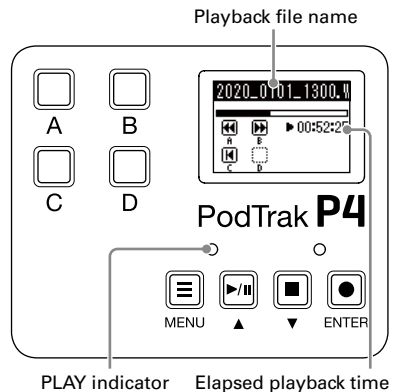

### HINT

Files can also be selected and played using MENU screen > Files > select file > Play.

## Transferring files to a computer, smartphone or tablet

Recorded files can be transferred to computers, smartphones and tablets.

1. Select **File Transfer** on the MENU screen.
2. Use a USB cable to connect the **P4** with a computer, smartphone or tablet (→ page 10).
3. Transfer the files needed.

### ■ P4 folder and file structure

When recording with the **P4**, folders and files are created on SD cards in the following manner.

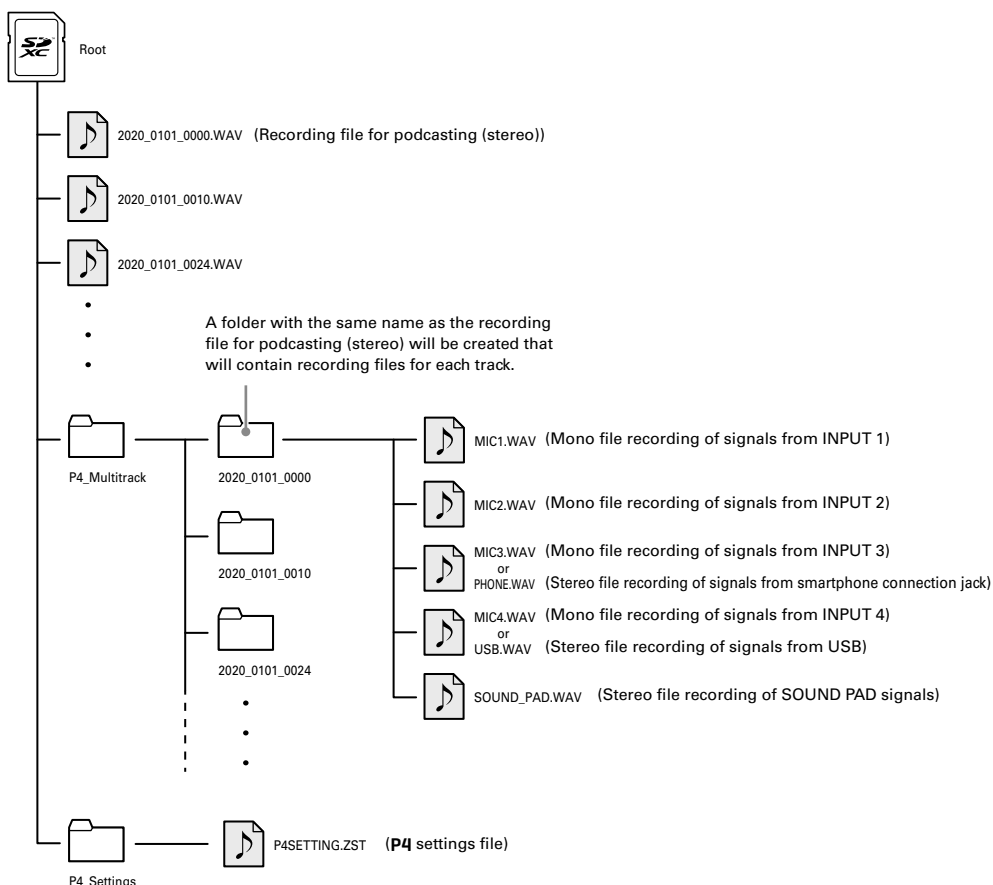

## Using SOUND PAD functions

Audio files can be assigned to the SOUND PAD buttons. Press one to play the assigned file. These are convenient to play opening and closing music as well as interviews that have been recorded in advance. The volume and playback method can be set for each pad.

### ■ Assigning audio files to SOUND PAD buttons

Built-in sounds and audio files saved on an SD card can be assigned to SOUND PAD buttons.

1. Select **Sound Pad** on the MENU screen.
2. Select the SOUND PAD (A–D) to which you want to assign an audio file.
3. Select **Sound Assign**.  
The built-in sound sources or the audio files stored on the SD card are shown in the list.
4. Select the audio file that you want to assign.

#### NOTE

To assign a file on an SD card to a SOUND PAD, use a computer beforehand to store the audio file on the card in any directory other than the P4\_Multitrack and P4\_Settings folders.

### ■ Playing SOUND PAD buttons

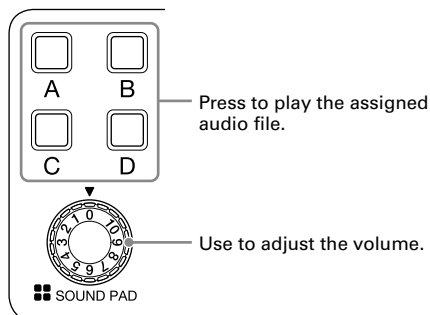

When a SOUND PAD button is played, the file name will be shown on the display for two seconds after playback starts.

### ■ Changing playback methods and volumes for each SOUND PAD

1. Select **Sound Pad** on the MENU screen.
2. Select the SOUND PAD (A–D) for which you want to change settings.
3. Change the settings.

#### Play Mode (playback method used when a SOUND PAD button is pressed)

- **One Shot**: Each press plays the file once from beginning to end.
- **Pause**: Each press alternately plays and pauses. Playback stops at the end of the file. Press and hold (for 2 seconds) when paused to return to the beginning of the file.
- **Loop**: Each press alternately plays and pauses. Playback will loop until stopped.
- **Hold**: While pressing, loop playback will continue. When released, playback will stop.

#### Level (volume setting)

- **-48dB–+10dB** (30 steps): Adjust the volume.

#### HINT

When a setting is changed, the changed state will be saved.

## Other functions and settings

### Changing file names

MENU screen > Files > select file name to be changed > Rename > input file name

### Deleting files

MENU screen > Files > select file to delete > Delete > Execute (Cancel: cancel)

### Using as an audio interface

The **P4** can be used as a 2-in/2-out audio interface.

### Connections

Connect the **P4** to a computer, smartphone or tablet. (→ page 10)

### Input settings

USB audio is input in stereo on INPUT 4. Set INPUT SELECT switch 4 to , and use the INPUT 4 knob to adjust the volume.

### USB Mix Minus settings

MENU screen > Settings > USB Mix Minus

- Off: Sound from USB input is also output by USB.
- On: Sound from USB input is not output by USB.

### Modifying the date and time

MENU screen > Settings > Set Date/Time > modify the date and time > confirm with OK

### Setting the type of batteries used

MENU screen > Settings > Battery

- Alkaline: Alkaline batteries
- Ni-MH: Nickel-metal hydride batteries
- Lithium: Lithium batteries

### Adjusting the display contrast

MENU screen > Settings > LCD Contrast > adjust the contrast (1–10)

### Setting the Auto Power Off function

MENU screen > Settings > Auto Power Off

- On: The power will automatically turn off if not used for 10 hours.
- Off: The power will not turn off automatically.

### Testing SD cards

MENU screen > Settings > SD Card > Card Test

- Quick Test: Conduct brief test
  - Full Test: Conduct complete test
- (Execute: execute, Cancel: cancel)

### Formatting SD cards

MENU screen > Settings > SD Card > Format > Execute (or Cancel to cancel)

#### NOTE

Be aware that all data previously saved on the SD card will be deleted when it is formatted.

### Restoring factory default settings

MENU screen > Settings > Factory Reset > Execute (or Cancel to cancel)

#### NOTE

A factory reset will overwrite all settings to their factory defaults. Be certain before using this function.

# Main Specifications

|   |   |   |
|---|---|---|
| Number of input channels                            | 4 (mono/stereo)   |   |
| Number of output channels                           | 1 (headphone x 4)   |   |
| Connectors  | MIC   | XLR jacks (2: HOT)  |
|   | Smartphone connection jack  | TRRS mini jack (4 contacts, TIP: L, RING1: R, RING2: GND, SLEEVE: MIC)  |
|   | USB   | USB Type-C (audio interface and mass storage functions)<br>Note: Use a USB cable that supports data transfer. USB bus power is supported. |
|   | DC 5 V  | USB Type-C (for power supply)   |
| Headphones  | 3.5 mm stereo mini  |   |
| Phantom power                                       | +48 V   |   |
| Recorder  | Formats   | WAV 44.1 kHz, 16-bit, mono/stereo   |
|   | Recording media   | 4 GB–32 GB SDHC-compliant cards (Class 10 or higher)<br>64 GB–512 GB SDXC-compliant cards (Class 10 or higher)                            |
| Audio interface                                     | 44.1 kHz, 16-bit, 2-in/2-out  |   |
| Power   | 2 AA batteries (alkaline, NiMH or lithium)<br>• We recommend using NiMH batteries with the <b>P4</b> .<br>AC adapter (ZOOM AD-17): DC 5 V/1 A (USB bus power is supported.)   |   |
| Estimated continuous operation time using batteries | Recording 44.1 kHz/16-bit/4ch audio to SD card (when 48 V is OFF and headphone impedance is 63 Ω)<br>Alkaline batteries: about 4 hours<br>NiMH batteries (1900 mAh): about 4.5 hours<br>Lithium batteries: about 9 hours<br>• The above values are approximate.<br>• Continuous battery operation times were determined using in-house testing methods. They will vary greatly according to use conditions. |   |
| External dimensions                                 | 112 mm (W) × 155 mm (D) × 47 mm (H)   |   |
| Weight (unit only)                                  | 290 g   |   |



ZOOM CORPORATION

4-4-3 Kanda-surugadai, Chiyoda-ku, Tokyo 101-0062 Japan

[www.zoom.co.jp](http://www.zoom.co.jp)